



Canvas
SHELVING SYSTEM



Modular
SYSTEM



Roll'n
SERVICE CARTS



CLIX
TABLES

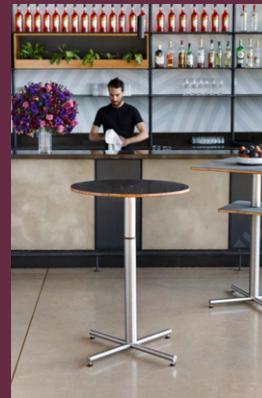

POLO
TABLES



Grabit
SIDE TABLES

mogogo

2022/2023
COLLECTIONS



Modular

SYSTEM

mogogo



CLASSIC SMALL UNIT C-MLX-03-GSXF

INDEX

 New Products

 Chef

 Waiter

 Bartender

 See Page



A PROFESSIONAL
FOOD & BEVERAGE
FURNITURE COMPANY

BORN FROM A PASSION FOR Style & Gastronomy



Mogogo is led by designers and chefs that are aiming to introduce innovative, luxurious, and highly functional equipment to foodservice professionals.

A PERFECT BALANCE
OF LUXURY AND FUNCTION



LINENLESS



MODULAR



MOBILE



SUSTAINABLE



ADD ONS



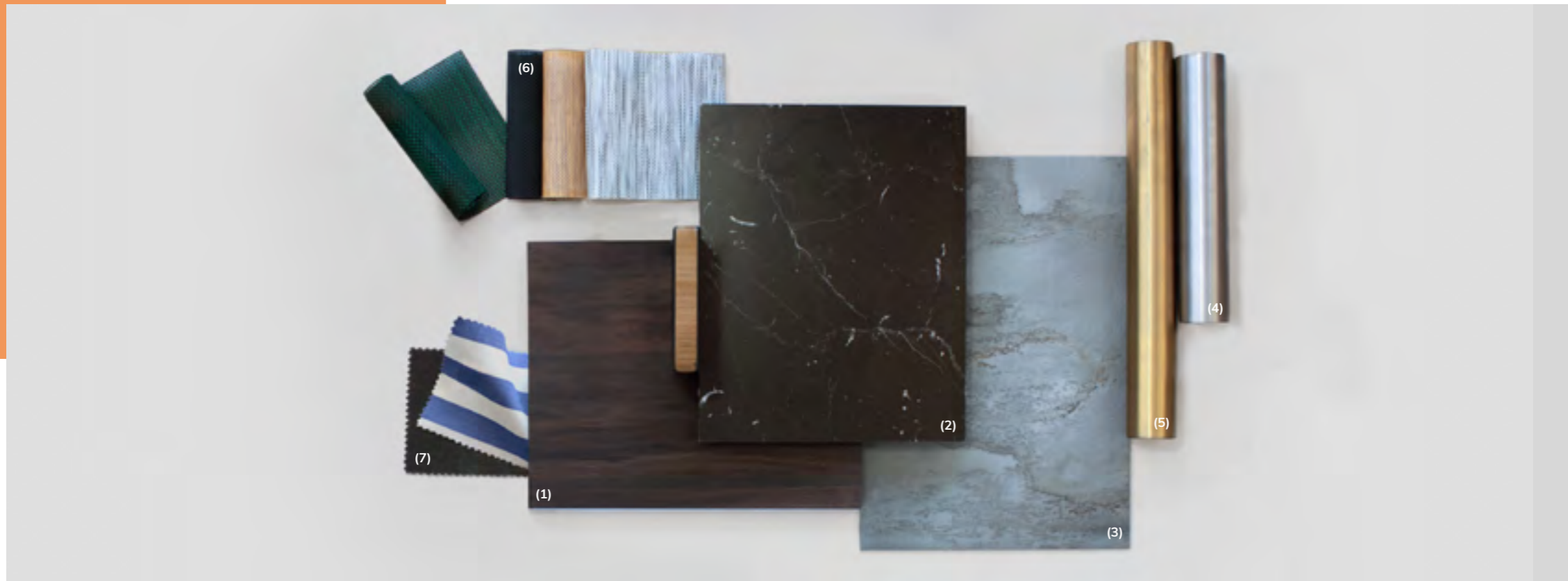

ABOUT MODULAR COLLECTION

Mogogo's flagship collection, the Modular System, allows you to use the same components in various ways to create different configurations of products. Our Modular System Line is composed of our Classic and Creative Ranges, and a large variety of complementary accessories.

Our Classic Range consists of buffet tables and shelves that fit each other seamlessly, functioning as building blocks to the Mogogo System. The classic range is characterized by sleek linear design, adaptable to both traditional and more modern, edgier looks.

Our Creative Range comes with a curved design concept. Our Creative system is patented and offers unique features based on our vast experience in large food service operations.

Our stations are carefully designed maintaining a delicate balance between high functionality, durability, and mobility; all in perfect symbiosis with high design standards, providing an ideal solution for the Food and Beverage industry.

 Classic Range |
  Creative Range

MATERIALS

Modular collection tops are made of our innovative BHP material. BHP is a newly composed material that arrived after two years of intense R&D. It merges layers of High-Pressure Laminate with a Vertical Bamboo core (Mogogo's expertise) creating a lighter yet durable panel that offers new textures and colors. This new material combines the advantages of both bamboo and HPL, perfect for the ever-changing needs of the hospitality industry. BHP is available in a variety of finishes that resemble natural materials such as Bengali Mango Wood, Nero Marquina Marble, and Grey Slate, (1-3), making it easy to match with any event and decor. The innovative bamboo core of the BHP goes in line with Mogogo's sustainability motto while the HPL's outer coating is durable for different environments, hygienic and easy to clean.

Modular segments come in 2 finishes- brushed stainless steel (4) and brushed brass (5).

Easily cover up parts of your buffet stations with our original quick covers (6). Both durable and easy to clean, they come in 4 different color options allowing you to easily match any of your event color schemes.

For that extra outdoor feel, add a canopy (7) to your buffet station, made from a sturdy Cordura fabric known for its resistance to abrasions, tears, and scuffs.

HOW IT WORKS

The Mogogo Modular System is composed of individual parts, which can be assembled to create endless configurations. These individual components sit at the core of the Mogogo Modular System. In fact, they are utilized as the base for creating Action Stations, Buffet Stations, Bar Stations, and more when combined with add-ons, in order to offer the perfect customized touch for all of your buffet solution needs.

All Buffet Stations have essential elements: tabletops, mid-part segments, and leg segments (permanent or mobile casters). From there, you can start choosing your add-ons: different shelves, sign posts, quick covers, arches, etc., for the ultimate customization.

What is unique about Mogogo's configurations is the freedom of building any stations you want from the exact same parts. Start with a Basic Station and add shelves: it makes for the ideal Breakfast Station. Add a different tabletop and covers: it becomes an elegant Bar Station. When the sum of parts is bigger than the whole, we deliver on unique and endless possibilities.

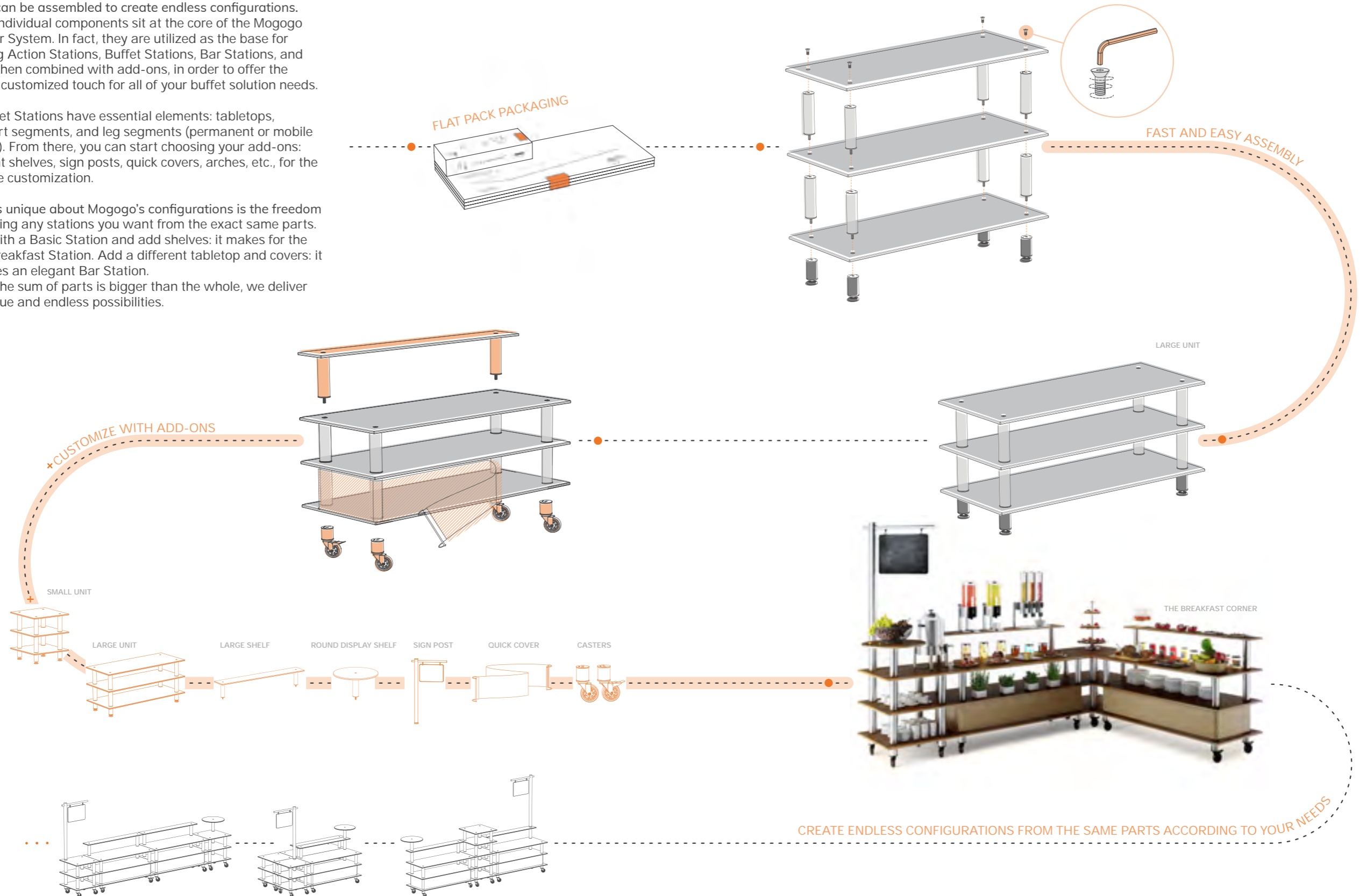

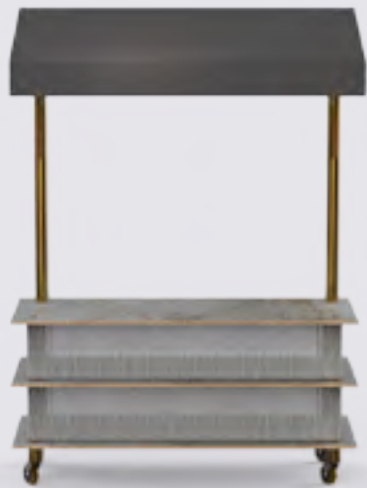

C-MLB-10-GBBW (shown with optional quick covers)



C-MLA-06-WSXW (shown with optional quick covers)

Mogogo's unique Modular system allows its stations to be extremely versatile and functional. By adding different elements you can custom fit any event or venue. These add-ons are easy to incorporate and provide edgy looks that will stand out.



C-MLD-12-MSXW (shown with optional quick covers)

ADD-ON COMBINATIONS



C-MLB-11-MBXW (shown with optional quick covers)



C-MLB-12-GBXF



*
The different finishes combined with brass or stainless steel create infinite options for styling.



C-MLC-05-MSXW (shown with optional quick covers)





OPEN C SERVING STATION C-MSA-01-WBXF
(shown with optional Golden-Brown quick covers)

ACTION STATIONS

Guests' fascination with chefs, food preparation, and presentation around the Action Station continues to grow and evolve in events today - it's a great way to add some spice and surprise to your culinary landscape.

Mogogo's Action Stations are designed to enhance the interactive experience of your guests through elegant design, while providing chefs and F&B professionals all the functional elements they are looking for. From an omelet station to a make-it-your-own dish station, Mogogo Action Stations are extremely modular; our ever-expanding line of add-ons and a wide range of tabletops deliver functionality and authenticity.

Cooking in front of the guest entices all their senses - and we believe beautifully crafted furniture is part of the experience.

MATERIAL GUIDE

Customize your Modular Stations by choosing from the different colors and finishes available. Simply choose your preferred design combination by inserting the corresponding letter to its designated space as demonstrated below.

Item code: C-###-## - Design combination: TOP SEGMENT TEXTILE BASE

TOP	SEGMENT	TEXTILE	BASE
M Nero Marquina Marble BHP	S Brushed Stainless Steel	W Blue and White stripes	F Adjustable legs
G Grey Slate BHP	B Brushed Brass	B Black	W Casters
W Bengali Mango Wood BHP			

EXAMPLE:

C-MLB-10- **G B W F** =



OPEN C SERVING STATION

Neither round nor square, this station creates a minimalist and functional approach, designed to serve large crowds with minimal effort.

C-MSA-01- **W S X F**



CLASSIC CANOPY STATION

A contemporary Food Market Station, perfect for putting on a show. accessorized with a hygienic Stainless steel top and a breath guard. (shown with optional Silver-Grey quick covers)

C-MLA-04- **M S W F**



CREATIVE DIY STATION

Combining circular and linear units, this design layout makes for the ideal make-your-own dish station that enhances the customer's experience. (shown with optional Charcoal-Black quick covers)

C-MSA-02- **G S X F**



PRO SALSA BAR STATION

This station provides chefs with a perfect combination of a stainless steel workspace with extra storage and display areas to impress their diners. (shown with optional Charcoal-Black quick covers)

C-MLA-02- **M S X W**



BAZAAR ACTION STATION C-MLA-03-GSWW
(shown with optional Silver-Grey quick covers)



SMALL S BUFFET C-MSB-03-GSXW
 (shown with optional Large Oval high display shelf and Small Oval low display shelf)



BUFFET STATIONS

As a fundamental functional element to any F&B operation, we believe Buffet Stations no longer need to be hidden under heavy linens nor lifted by the staff.







Mogogo takes an innovative and sustainable approach to Buffet Stations by introducing new design and functionality for linenless F&B Furniture, revealing beautiful clean lines. The presentation of a station is just as important as the quality of food being served and Mogogo offers ideal solutions for Chefs to display their most exquisite dishes. From Classic to Creative, Mogogo Buffet Stations offer a wide range of display and self-service options. Above, add shelves to elevate the dining experience of your guests; below, add our Quick Covers to conceal extra storage space.

Maximize every corner of your catering space by mixing and matching between our Classic Range and Creative Range to reinvent the experience of self-service in events.

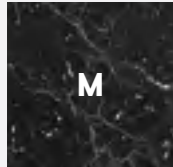
MATERIAL GUIDE

Customize your Modular Stations by choosing from the different colors and finishes available. Simply choose your preferred design combination by inserting the corresponding letter to its designated space as demonstrated below.

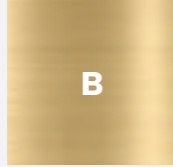
Item code: C-###-## - Design combination: TOP SEGMENT TEXTILE BASE

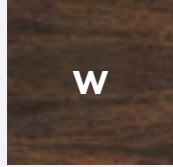
TOP	SEGMENT	TEXTILE	BASE
 M Nero Marquina Marble BHP	 S Brushed Stainless Steel	 W Blue and White stripes	 F Adjustable legs
 G Grey Slate BHP	 B Brushed Brass	 B Black	 W Casters
 W Bengali Mango Wood BHP			

EXAMPLE:

C-MLB-10- G B W F =



PRO CORNER STATION

Make the best use of space with this classic corner buffet station which gives all the advantages of a Mogogo station without taking up extra event space. (shown with optional Golden-Brown quick covers)

C-MLB-05- W S X W

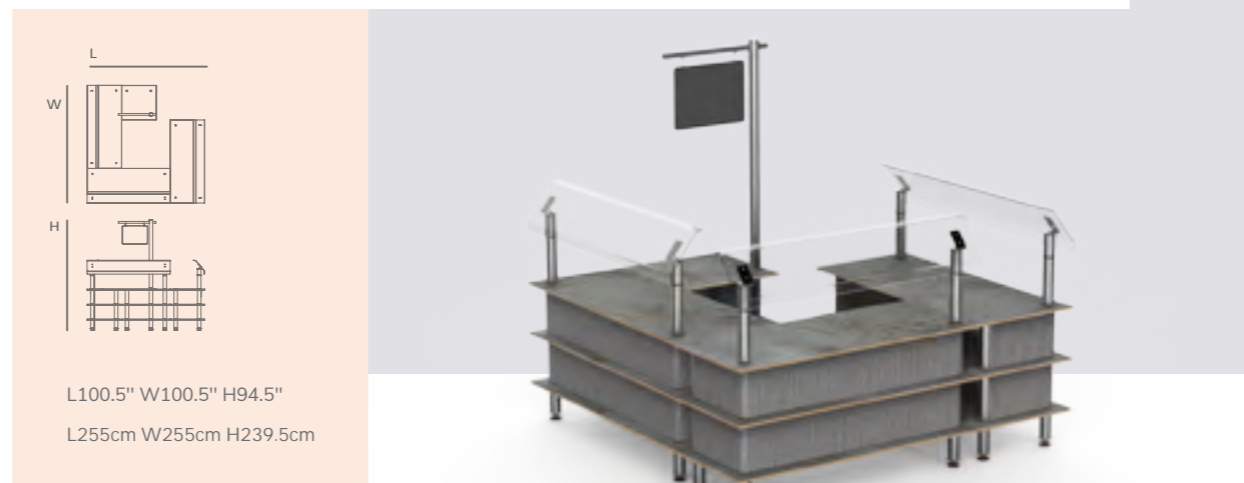

SELF SERVICE SALAD STATION

Make a statement in any event with this large food station equipped with protective self-service high breath guards and a signpost to attract guests. (shown with optional Silver-Grey quick covers)

C-MLB-06- G S X F



CLASSIC CURVED BUFFET STATION

This unique double-sided streamlined display station is not only beautiful but functional as well, designed to serve large crowds. (shown with optional Silver-Grey quick covers)

C-MLB-02- M B X W



BREAD AND PASTRY STATION

Create a focal point in any event with this extra high buffet station, giving more storage and presentation area than ever before. (shown with optional Golden-Brown quick covers)







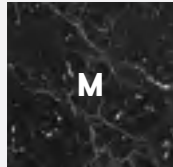

C-MLB-04- W S X F

MATERIAL GUIDE

Customize your Modular Stations by choosing from the different colors and finishes available. Simply choose your preferred design combination by inserting the corresponding letter to its designated space as demonstrated below.

Item code: C-###-## - TOP SEGMENT TEXTILE BASE

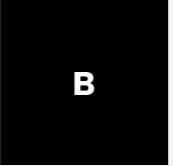
Design combination: TOP SEGMENT TEXTILE BASE

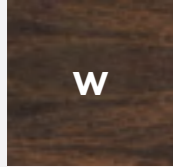
TOP	SEGMENT	TEXTILE	BASE
 M Nero Marquina Marble BHP	 S Brushed Stainless Steel	 W Blue and White stripes	 F Adjustable legs
 G Grey Slate BHP	 B Brushed Brass	 B Black	 W Casters
 W Bengali Mango Wood BHP			

EXAMPLE:

C-MLB-10- G B W F =



MARKET SQUARE

The classic look and feel of a traditional market with a modern flair gives this configuration all the functionality and practicality a large buffet station needs.

C-MLB-07- W B X F



ROUND MARKET

Acting not only as the event's focal point, this 360-degree buffet experience will also prevent chaotic queues.

C-MSB-01- M S X F



MULTI HEIGHT DISPLAY STATION

Create unforgettable events with this eye-catching display station, scattered with interchangeable display shelves in different heights. (shown with optional Charcoal-Black quick covers)

C-MLB-08- M B X F

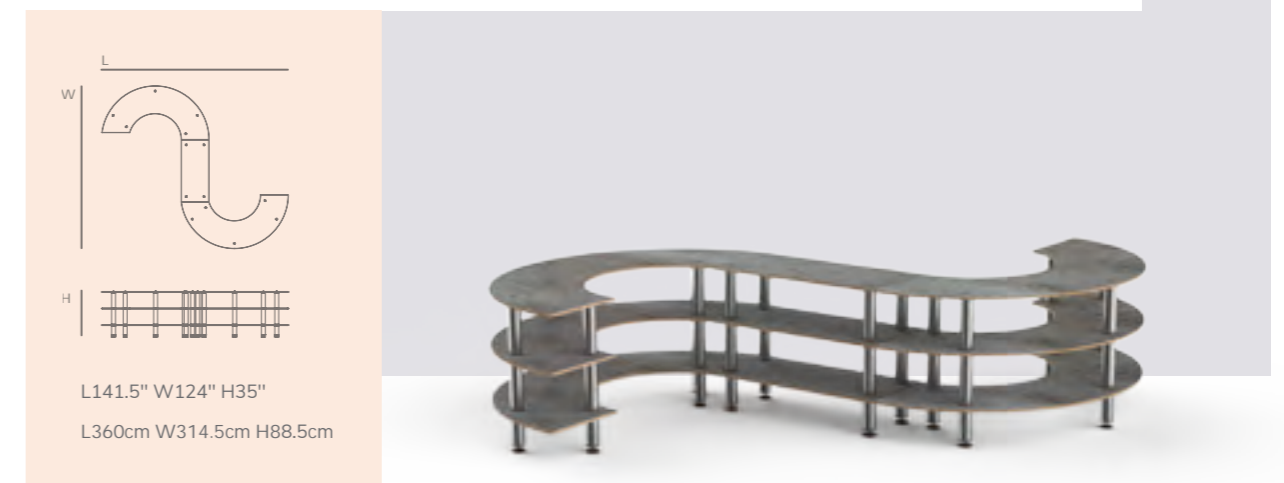

MEDIUM S BUFFET

Avoid hectic buffet lines with Mogogo's Creative S station which gives a smooth crowd flow in any event.

C-MSB-02- G S X F



ALL STAINLESS PRO BAR C-MLC-06-MSXW
 (shown with optional Charcoal-Black quick covers)



BAR STATIONS

Redefine guests' expectations in any F&B operation by elevating their drink and beverage standards. From classic wine bars to mixology & curated cocktails - Bar Stations across your venue are an opportunity to make a statement.

Mogogo's Bar Station Collection features highly adaptable stations which can be used in a wide range of event types and sizes. Easily transportable from one venue to another thanks to their heavy-duty casters, Mogogo Bar Stations combine sleek design and high functionality.

Customize your station with our versatile Add-Ons and quickly conceal bottom shelves for additional storage with our Quick-Covers.

Everything in foodservice, for guests or chefs, is about the experience. Mogogo Bar Stations deliver on the promise of innovative functional design.

MATERIAL GUIDE

Customize your Modular Stations by choosing from the different colors and finishes available. Simply choose your preferred design combination by inserting the corresponding letter to its designated space as demonstrated below.

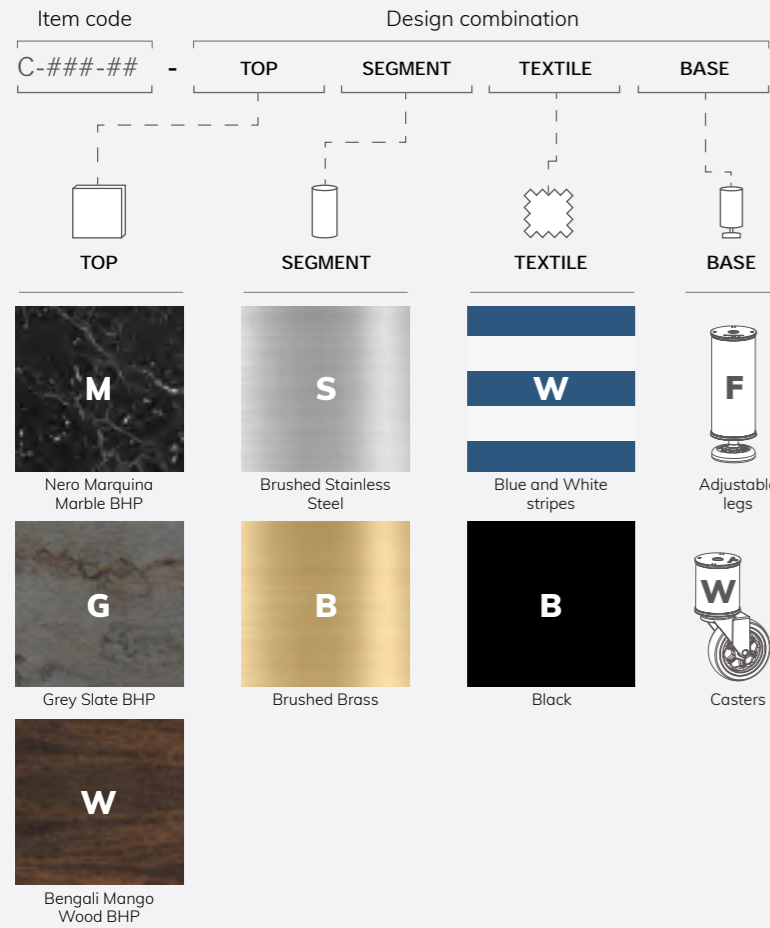

EXAMPLE:

C-MLB-10- G B W F =



PRO BAR & BACK BAR STATIONS

The Pro Bar is equipped with a stainless steel working surface, ice bin and speed-rail. Combined with a Mogogo back bar, it's a bartender's dream.

(shown with optional Silver-Grey quick covers)

PRO BAR C-MLC-05- W S X W

BACK BAR C-MLC-02- W S X W



ALL STAINLESS PRO BAR & BACK BAR STATIONS

Mogogo's classic Pro and Back Bars get an updated look with all stainless tops for an extra professional look and feel.

(shown with optional Charcoal-Black quick covers)

ALL STAINLESS PRO BAR C-MLC-06- M S X W

ALL STAINLESS BACK BAR C-MLC-04- M S X W



MIXOLOGY BAR STATION

Designed to accommodate the most sophisticated Mixologists, this is the ultimate design element for a show-stopping cocktail mixing experience.

(shown with optional Charcoal-Black quick covers)

C-MLC-07- G S B W



DOUBLE BAR STATION

The Double Bar allows serving beverages to guests anytime, anywhere. This portable yet classy design does it all.

(shown with optional Golden-Brown quick covers)

C-MLC-11- W B X F

DAY & NIGHT

Modular stations can perfectly display breakfast buffets or help entertain guests at the next cocktail party.



CLASSIC PLUS C-MLB-13-WSXW
(shown with optional Golden-Brown quick cover)



PRO BAR C-MLC-05-MSXW
(shown with optional Silver-Grey quick covers)



STREAMLINE ARCH INDUCTION STATION C-MLD-05-MSXW
(shown with optional Charcoal-Black quick covers)

WARMING AND COOKING STATIONS

The visual appeal of the colors and textures of the food, the aroma as it is prepared, and the sounds of sizzling pans... Cooking and Warming Stations generate excitement, curiosity, and can be a great catalyst for social interaction.

Now, Cooking and Warming Stations are redesigned as one modern and beautifully crafted element to seamlessly blend with your hospitality design standards. Designed as a modular extension to our existing function-based tabletops, Mogogo Cooking and Warming Stations offer your chefs high-functionality, mobility, and add a sense of theater for a special catering experience.

Your guests want creativity and variety. Introduce them to new culinary territories and let them discover new sensations with Mogogo's Cooking and Warming Stations.

MATERIAL GUIDE

Customize your Modular Stations by choosing from the different colors and finishes available. Simply choose your preferred design combination by inserting the corresponding letter to its designated space as demonstrated below.

Item code: C-###-## - Design combination

TOP	SEGMENT	TEXTILE	BASE
M Nero Marquina Marble BHP	S Brushed Stainless Steel	W Blue and White stripes	F Adjustable legs
G Grey Slate BHP	B Brushed Brass	B Black	W Casters
W Bengali Mango Wood BHP			

EXAMPLE:

C-MLB-10- **G B W F** =



DOUBLE HEAT BUFFET TABLE

No need for a plug. This station uses canned heat to keep food warm during entire events.

(shown with optional Jungle-Green quick covers)

C-MLD-04- W S X W

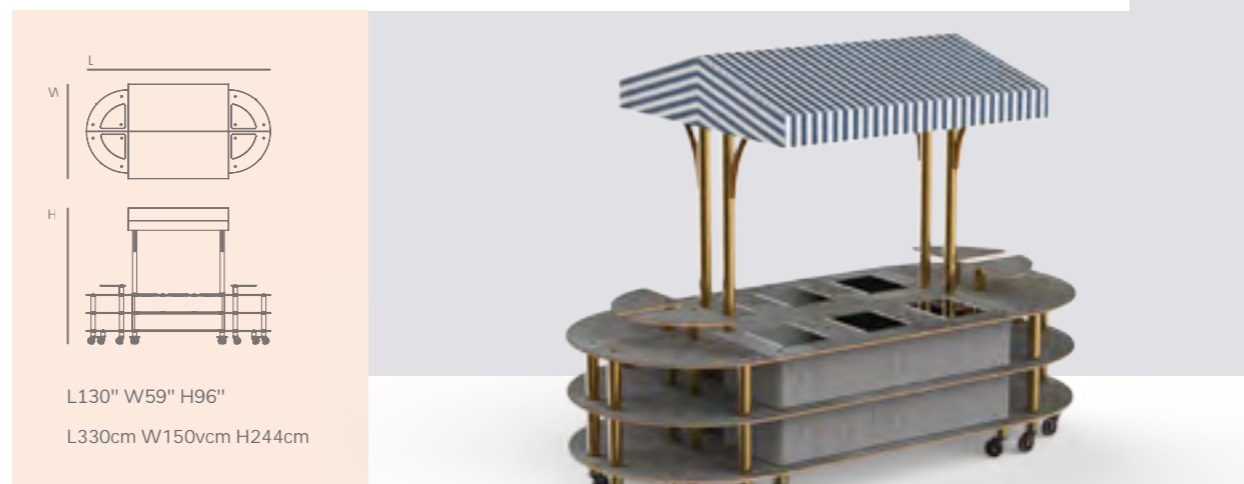

ROUNDED WARMING INDUCTION MARKET STATION

This stand-out station makes serving large crowds easy while keeping food warm on six drop-in induction units.

(shown with optional Silver-Grey quick covers)

C-MLD-03- G B W W



PRO COOKING INDUCTION

Drop-in cooking induction ranges give the freedom to bring a kitchen atmosphere within an event space for unique interactions with guests.

(shown with optional Charcoal-Black quick covers)

C-MLD-01- M S X W



LARGE ARCH INDUCTION STATION

Combining drop-in induction ranges with additional space for mise en place - the ultimate comfort for chefs.

(shown with optional Golden-Brown quick covers and Long Blackboard)

C-MLD-02- W S X W



HEAT TABLE C-MLD-06-WSXW
(shown with optional Golden-Brown quick covers)

TRANSFER & STORAGE CARTS

Designed for convenience and mobility, Mogogo's utility carts are an integral part of the Modular system as they make storing and assembling the stations an easy task. Whether it is to push them through the halls, or get in and out of elevators, they make the behind the scenes of your time-sensitive events easier and give you an extra push on productivity. The carts can store up to five large Classic units or four large Creative units while the orange vinyl coated areas ensure comprehensive tabletop protection.

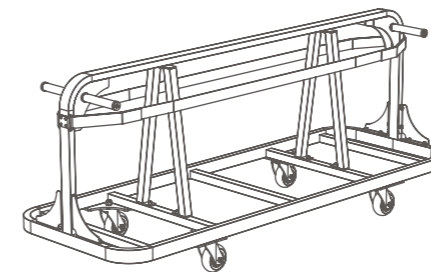
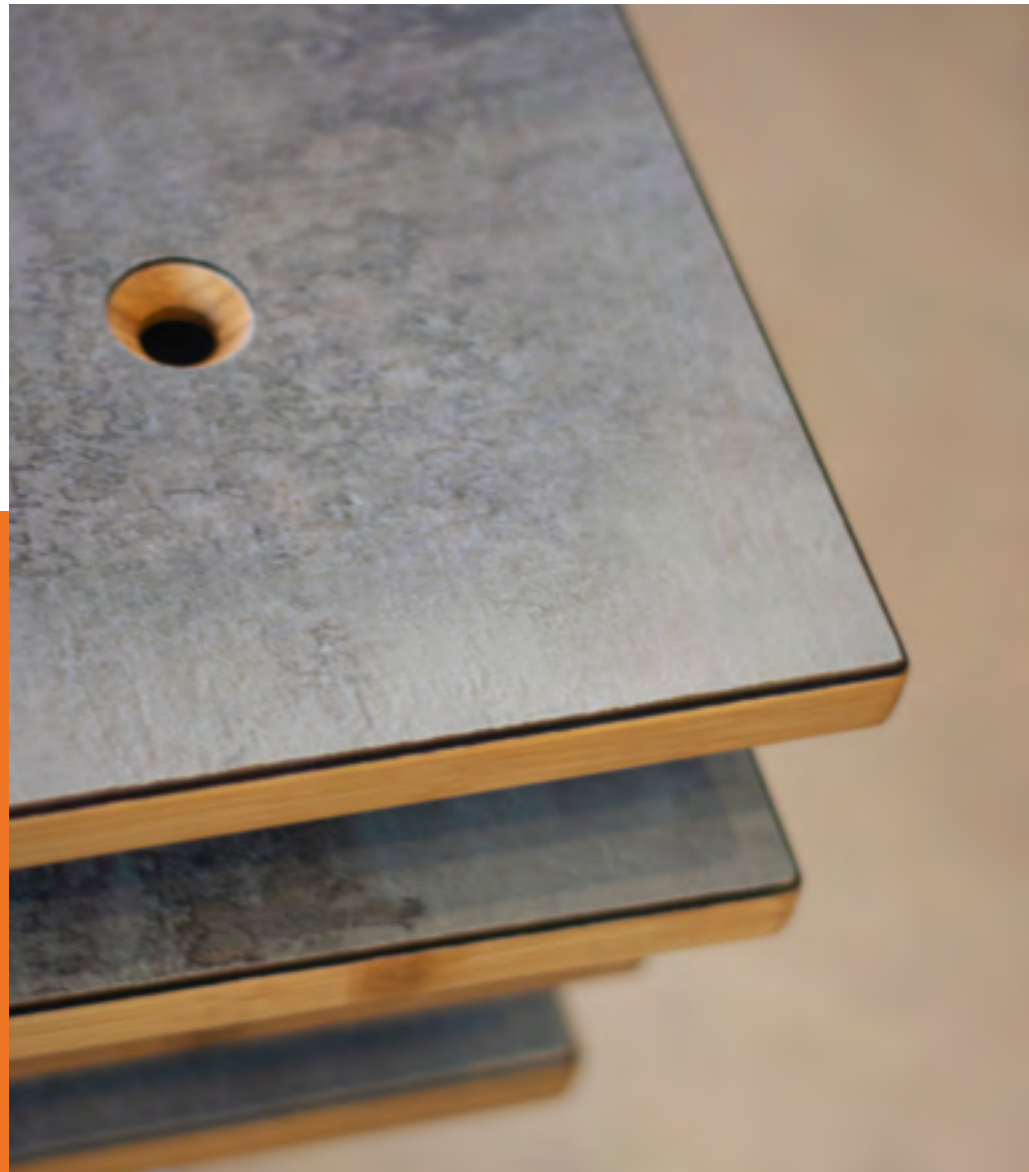

**LARGE PLATE
TRANSFER AND STORAGE CART**
L86.5" W31" H36.5"
L220cm W79cm H92.5cm
holds up to 18 tabletops

C-UUX-03-XXXX



**SEGMENTS AND ADD-ONS
TRANSFER AND STORAGE CART**
L55.5" W31" H50"
L141cm W79cm H127.5cm
holds 7-9 modular unit segments and legs/casters
+ dedicated storage space for multiple modular add-ons

C-UUX-01-XXXX



71" BREATH GUARD C-IAN-01-XSXX

SYSTEM BREAKDOWN

Mogogo's Modular System is based on a wide range of individual parts, which can be stacked up & assembled to design a variety of stations.

Our Modular System stems from the simple idea that your F&B Furniture should adapt to your ever-varying needs during different event sizes, types, and themes. It allows you to pick and choose basic elements such as tabletops, leg segments, casters, shelves, and other add-ons.

Endless vertical and horizontal possibilities exist while choosing between our functional tabletops: from classic to cooking, warming and bar tabletops, or picking your material and finishes of choice. Mogogo's Modular System gifts you an ocean of possibilities.

UTILITY KIT



ALLEN KEY FOR M16
2 M16 SCREWS
4 SCREW CAPS

S-SAC-SM-01

MATERIAL GUIDE

Customize your Modular Stations by choosing from the different colors and finishes available. Simply choose your preferred design combination by inserting the corresponding letter to its designated space as demonstrated below.

Item code: C-###-## - Design combination

TOP SEGMENT TEXTILE BASE

TOP: M (Nero Marquina Marble BHP), G (Grey Slate BHP), W (Bengali Mango Wood BHP)

SEGMENT: S (Brushed Stainless Steel), B (Brushed Brass)

TEXTILE: W (Blue and White stripes), B (Black)

BASE: F (Adjustable legs), W (Casters)

EXAMPLE:

C-MLB-10- G B W F =



CREATIVE RANGE

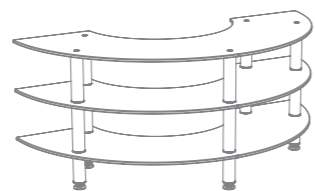

CREATIVE CURVED UNIT
L81.5" W41" H35"
L207cm W104cm H88.5cm

C-MSX-01- __ X _



CREATIVE EXTENSION UNIT
L47" W21" H35"
L120cm W54cm H88.5cm

C-MSX-02- __ X _

CLASSIC RANGE

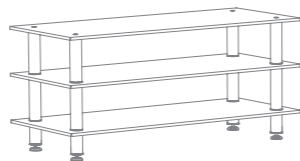

CLASSIC LARGE UNIT
L71" W29.5" H35"
L180cm W75cm H88.5cm

C-MLX-01- __ X _



CLASSIC MEDIUM UNIT
L47" W29.5" H35"
L120cm W75cm H88.5cm

C-MLX-02- __ X _

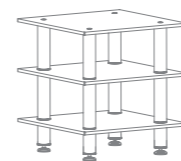

CLASSIC SMALL UNIT
L29.5" W29.5" H35"
L75cm W75cm H88.5cm

C-MLX-03- __ X _

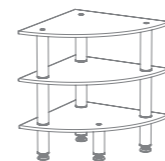

CLASSIC CORNER UNIT
L29.5" W29.5" H35"
L75cm W75cm H88.5cm

C-MLX-04- __ X _

STANDARD RANGE

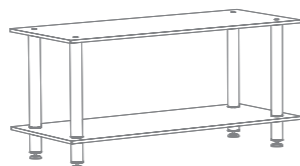

STANDARD LARGE UNIT
L71" W29.5" H35"
L180cm W75cm H88.5cm

C-MDX-01- __ X _

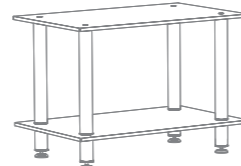

STANDARD MEDIUM UNIT
L47" W29.5" H35"
L120cm W75cm H88.5cm

C-MDX-02- __ X _

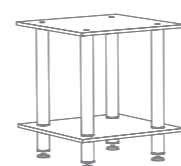

STANDARD SMALL UNIT
L29.5" W29.5" H35"
L75cm W75cm H88.5cm

C-MDX-03- __ X _

CREATIVE RANGE SHELVES

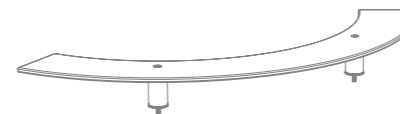

CURVED OUTER SHELF
L76" W27.5" H6.5"
L193cm W70cm H16.5cm

C-IAF-01- __ XX



CURVED INNER SHELF
L53" W26.5" H6.5"
L135cm W68cm H16.5cm

C-IAF-02- __ XX

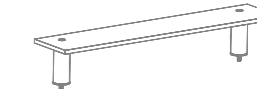

EXTENSION SHELF
L47" W10" H6.5"
L120cm W25cm H16.5cm

C-IAF-03- __ XX

CLASSIC RANGE SHELVES



LARGE SHELF
L71" W9.5" H12.5"
L180cm W24cm H32cm

C-IAF-04- __ XX



LARGE LOW SHELF
L71" W9.5" H6.5"
L180cm W24cm H16.5cm

C-IAF-05- __ XX

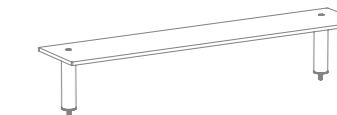

LARGE WIDE BAR SHELF
L71" W14.5" H12.5"
L180cm W37cm H32cm

C-IAF-06- __ XX



MEDIUM SHELF
L47" W9.5" H12.5"
L120cm W24cm H32cm

C-IAF-07- __ XX







MEDIUM LOW SHELF
L47" W9.5" H6.5"
L120cm W24cm H16.5cm

C-IAF-08- __ XX

MATERIAL GUIDE

Customize your Modular Stations by choosing from the different colors and finishes available. Simply choose your preferred design combination by inserting the corresponding letter to its designated space as demonstrated below.

Item code: C-####-## - Design combination

TOP	SEGMENT	TEXTILE	BASE
			
M Nero Marquina Marble BHP	S Brushed Stainless Steel	W Blue and White stripes	F Adjustable legs
G Grey Slate BHP	B Brushed Brass	B Black	W Casters
W Bengali Mango Wood BHP			

EXAMPLE:

C-MLB-10- **G B W F** =



CLASSIC RANGE DISPLAY SHELVES



HIGH SIDE SHELF
L29.5" W19" H12.5"
L75cm W47.5cm H32cm

C-IAY-01- __ XX

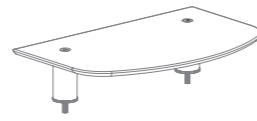

LOW SIDE SHELF
L29.5" W19" H6.5"
L75cm W47.5cm H16.5cm

C-IAY-02- __ XX



WIDE DISPLAY SHELF
L80" W12" H12.5"
L203cm W30.5cm H32cm
connects 2 mid-hole display tabletops

C-IAY-03- __ XX

DISPLAY SHELVES

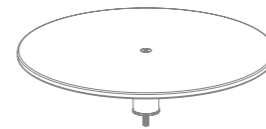

30" ROUND LOW DISPLAY SHELF
Ø30" H6.5"
Ø76cm H16.5cm

C-IAY-04- __ XX

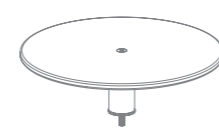

24" ROUND LOW DISPLAY SHELF
Ø24" H6.5"
Ø60cm H16.5cm

C-IAY-05- __ XX

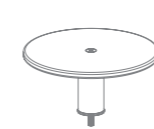

18" ROUND LOW DISPLAY SHELF
Ø18" H6.5"
Ø46cm H16.5cm

C-IAY-06- __ XX

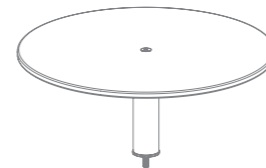

30" ROUND HIGH DISPLAY SHELF
Ø30" H12.5"
Ø76cm H32cm

C-IAY-07- __ XX

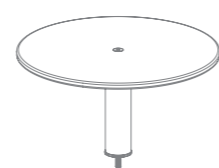

24" ROUND HIGH DISPLAY SHELF
Ø24" H12.5"
Ø60cm H32cm

C-IAY-08- __ XX

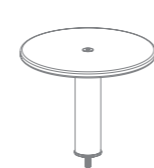

18" ROUND HIGH DISPLAY SHELF
Ø18" H12.5"
Ø46cm H32cm

C-IAY-09- __ XX

DISPLAY SHELVES

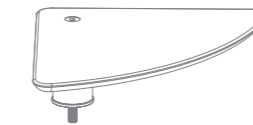

LARGE TRIANGLE LOW DISPLAY SHELF
L17" W17" H6.5"
L44cm W44cm H16.5cm

C-IAY-10- __ XX

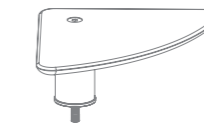

SMALL TRIANGLE LOW DISPLAY SHELF
L14" W14" H6.5"
L35cm W35cm H16.5cm

C-IAY-11- __ XX

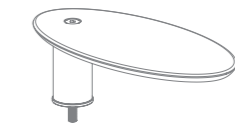

LARGE OVAL LOW DISPLAY SHELF
L20" W10" H6.5"
L50cm W25cm H16.5cm

C-IAY-14- __ XX

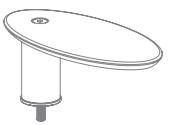

SMALL OVAL LOW DISPLAY SHELF
L16" W8" H6.5"
L40cm W20cm H16.5cm

C-IAY-15- __ XX

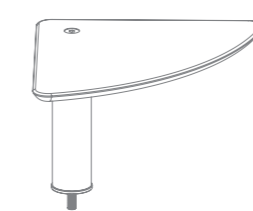

LARGE TRIANGLE HIGH DISPLAY SHELF
L17" W17" H12.5"
L44cm W44cm H32cm

C-IAY-12- __ XX

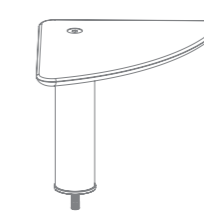

SMALL TRIANGLE HIGH DISPLAY SHELF
L14" W14" H12.5"
L35cm W35cm H32cm

C-IAY-13- __ XX

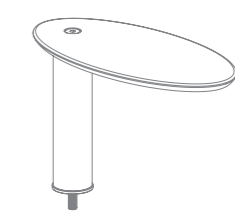

LARGE OVAL HIGH DISPLAY SHELF
L20" W10" H12.5"
L50cm W25cm H32cm

C-IAY-16- __ XX



SMALL OVAL HIGH DISPLAY SHELF
L16" W8" H12.5"
L40cm W20cm H32cm







C-IAY-17- __ XX

MATERIAL GUIDE

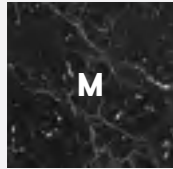
Customize your Modular Stations by choosing from the different colors and finishes available. Simply choose your preferred design combination by inserting the corresponding letter to its designated space as demonstrated below.

Item code: C-###-## - TOP SEGMENT TEXTILE BASE

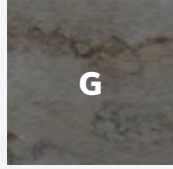
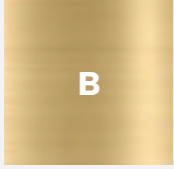
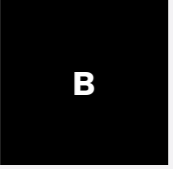
Design combination: TOP SEGMENT TEXTILE BASE

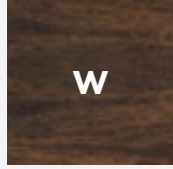
TOP	SEGMENT	TEXTILE	BASE
 M Nero Marquina Marble BHP	 S Brushed Stainless Steel	 W Blue and White stripes	 F Adjustable legs
 G Grey Slate BHP	 B Brushed Brass	 B Black	 W Casters
 W Bengali Mango Wood BHP			

EXAMPLE:

C-MLB-10- G B W F =



ADD-ONS

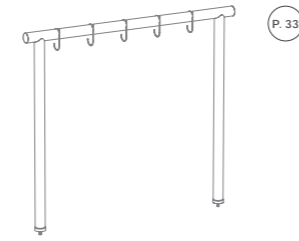

ARCH
L71" W3" H61"
L180cm W7.6cm H155cm
Fits large units

C-IAM-02- X _ XX

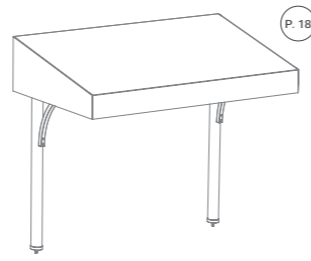

CANOPY
L71" W33.5" H61"
L180cm W85cm H155cm
Fits large units

C-IAM-03- X _ _ X

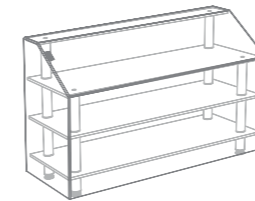

OUTDOOR PVC COVER
Fits large units with bar shelf

S-ADD-PV-01

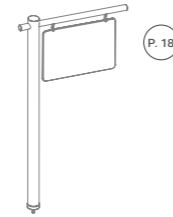

SIGN POST
L32" W3" H59"
L80.5cm W7.6cm H150cm
Fits all units

C-IAM-01- X _ XX

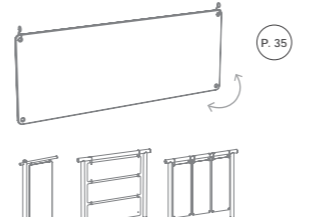

LONG BLACKBOARD
L47" H18"
L120cm H45cm
Fits Arch and Sign post

S-ADD-SM-02



BLACKBOARD COLLECTION
Fits Arch

S-ADD-SM-03

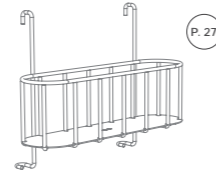

SPEEDRAIL
L18.5" W5" H14"
L47cm W13cm H36cm
Fits bar top

S-ADD-SS-06

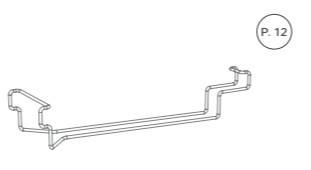

WINE GLASS HOLDER
L15" H2.5" W4.5"
L37.5cm H6.5cm W11cm
Fits Large wide bar shelf
Holds up to 6 wine glasses

S-ADD-SS-13

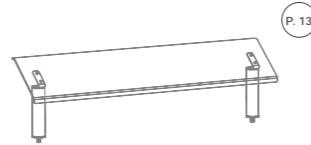

71" BREATH GUARD
H18.5" | gap H8.5"
H47cm | gap H22cm
Fits large units

C-IAN-01- X _ XX

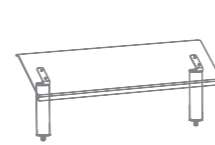

47" BREATH GUARD
H18.5" | gap H8.5"
H47cm | gap H22cm
Fits medium units

C-IAN-02- X _ XX

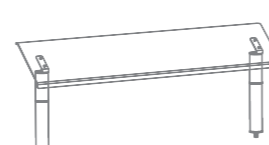

71" HIGH BREATH GUARD
H24.5" | gap H14"
H62cm | gap H36.5cm
Fits large units

C-IAN-03- X _ XX

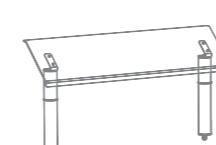

47" HIGH BREATH GUARD
H24.5" | gap H14"
H62cm | gap H36.5cm
Fits medium units

C-IAN-04- X _ XX

QUICK COVERS

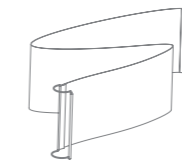

Fits Unit

Amount

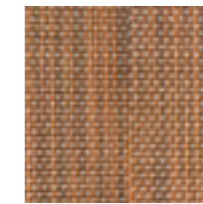

Golden-Brown

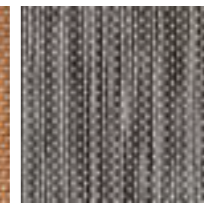

Silver-Grey

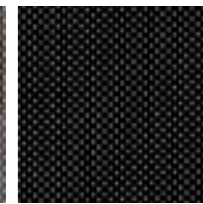

Charcoal-Black

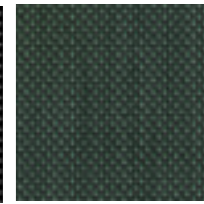

Jungle-Green

Fits Unit	Amount	Golden-Brown	Silver-Grey	Charcoal-Black	Jungle-Green
LARGE CLASSIC UNIT	2	S-QCO-PV-03	S-QCO-PV-04	S-QCO-PV-16	S-QCO-GP-02
MEDIUM CLASSIC UNIT	2	S-QCO-PV-05	S-QCO-PV-06	S-QCO-PV-17	S-QCO-GP-03
SMALL CLASSIC UNIT	2	S-QCO-PV-07	S-QCO-PV-08	S-QCO-PV-18	S-QCO-GP-04
CORNER CLASSIC UNIT	2	S-QCO-PV-24	S-QCO-PV-25	S-QCO-PV-26	S-QCO-GP-11
CURVED CREATIVE UNIT	2	S-QCO-PV-09	S-QCO-PV-10	S-QCO-PV-19	S-QCO-GP-05
EXTENSION CREATIVE UNIT	2	S-QCO-PV-11	S-QCO-PV-12	S-QCO-PV-20	S-QCO-GP-06
LARGE SHELF	1	S-QCO-PV-01	S-QCO-PV-02	S-QCO-PV-15	S-QCO-GP-01

SEGMENTS



Brushed Stainless Steel

Brushed Brass



5.7" SEGMENT
H5.7" | H14cm
available in sets of:
1 / 2

1 piece	S-LEG-SS-02	S-LEG-BR-04
2 pcs	S-LEG-SS-05	S-LEG-BR-09



12" SEGMENT
H12" | H30cm
available in sets of:
1 / 2 / 8

1 piece	S-LEG-SS-01	S-LEG-BR-03
2 pcs	S-LEG-SS-04	S-LEG-BR-08
8 pcs	S-LEG-SS-15	S-LEG-BR-10



STANDARD SEGMENT
H25" | H63cm
available in sets of:
1 / 4

1 piece	S-LEG-SS-17	S-LEG-BR-14
4 pcs	S-LEG-SS-18	S-LEG-BR-15

LEGS

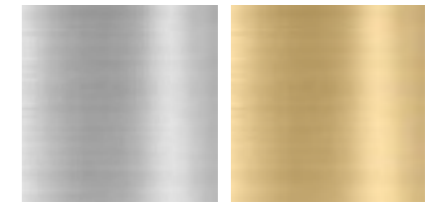

Brushed Stainless Steel

Brushed Brass



ADJUSTABLE LEGS
available in sets of:
1 single leg / 4 legs

1 piece	S-LEG-SS-13	S-LEG-BR-01
4 pcs	S-LEG-SS-14	S-LEG-BR-02

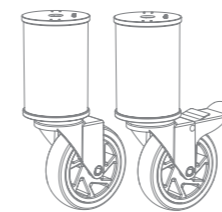

CASTERS
available in sets of:
1 with brake / without brake
4 casters (2 with brakes and 2 without)

1 piece with brake	S-ADD-SS-04	S-ADD-BR-06
1 piece without brake	S-ADD-SS-03	S-ADD-BR-05
4 pcs	S-ADD-SS-01	S-ADD-BR-04

CLASSIC RANGE TABLETOPS



Bengali Mango
Wood BHP

Grey Slate BHP

Nero Marquina
Marble BHP

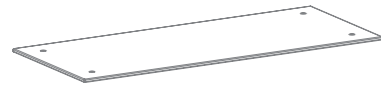

S-CTP-HW-01

S-CTP-HG-01

S-CTP-HB-01

LARGE RECTANGLE TOP
L71" W29.5"
L180cm W75cm



S-CTP-HW-02

S-CTP-HG-02

S-CTP-HB-02

MEDIUM RECTANGLE TOP
L47" W29.5"
L120cm W75cm

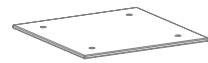

S-CTP-HW-03

S-CTP-HG-03

S-CTP-HB-03

SMALL SQUARE TOP
L29.5" W29.5"
L75cm W75cm

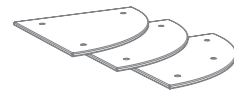

C-ILX-01-WXXX

C-ILX-01-GXXX

C-ILX-01-MXXX

CORNER UNIT TOP SET
L29.5" W29.5"
L75cm W75cm

CLASSIC RANGE SHELF TOPS



Bengali Mango
Wood BHP

Grey Slate BHP

Nero Marquina
Marble BHP

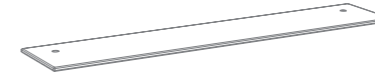

S-CLS-HW-02

S-CLS-HG-02

S-CLS-HB-02

LARGE WIDE BAR SHELF
L71" W14.5"
L180cm W37cm

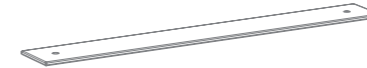

S-CLS-HW-01

S-CLS-HG-01

S-CLS-HB-01

LARGE SHELF
L71" W9.5"
L180cm W24cm



S-CLS-HW-03

S-CLS-HG-03

S-CLS-HB-03

MEDIUM SHELF
L47" W9.5"
L120cm W24cm

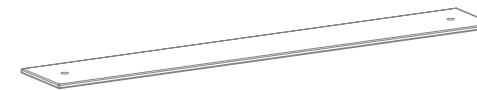

S-CLS-HW-05

S-CLS-HG-05

S-CLS-HB-05

WIDE DISPLAY SHELF
L80" W12"
L203cm W30.5cm
connects 2 mid-hole display tabletops



S-CLS-HW-08

S-CLS-HG-08

S-CLS-HB-08

SIDE SHELF
L29.5" W19"
L75cm W47.5cm

CREATIVE RANGE TABLETOPS

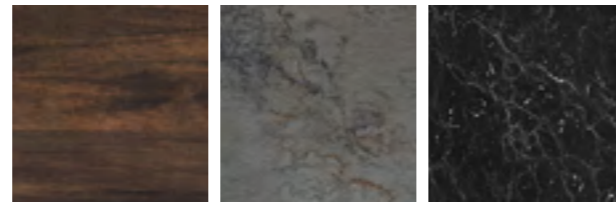

Bengali Mango
Wood BHP

Grey Slate BHP

Nero Marquina
Marble BHP



S-CTB-HW-01

S-CTB-HG-01

S-CTB-HB-01

LARGE ROUND TOP
L81.5" W41"
L207cm W104cm



S-CTB-HW-02

S-CTB-HG-02

S-CTB-HB-02

47" EXTENSION TOP
L47" W21"
L120cm W54cm

CREATIVE RANGE SHELF TOPS



S-CSV-HW-01

S-CSV-HG-01

S-CSV-HB-01

CURVED OUTER SHELF
L76" W27.5"
L193cm W70cm



S-CSV-HW-02

S-CSV-HG-02

S-CSV-HB-02

CURVED INNER SHELF
L53" W26.5"
L135cm W68cm



S-CSV-HW-08

S-CSV-HG-08

S-CSV-HB-08

EXTENSION SHELF
L47" W10"
L120cm W25cm

DISPLAY SHELF TOPS FOR CLASSIC AND CREATIVE RANGES

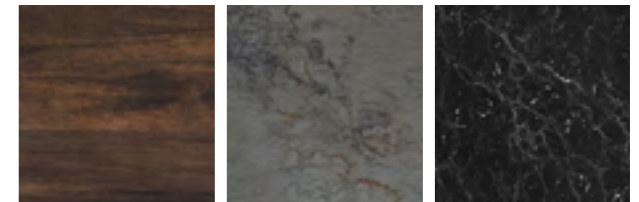

Bengali Mango
Wood BHP

Grey Slate BHP

Nero Marquina
Marble BHP

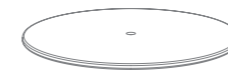

S-CRT-HW-01

S-CRT-HG-01

S-CRT-HB-01

30" ROUND TOP
Ø30" | Ø76cm



S-CRT-HW-02

S-CRT-HG-02

S-CRT-HB-02

24" ROUND TOP
Ø24" | Ø60cm

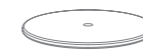

S-CRT-HW-03

S-CRT-HG-03

S-CRT-HB-03

18" ROUND TOP
Ø18" | Ø46cm



S-CLS-HW-06

S-CLS-HG-06

S-CLS-HB-06

**LARGE TRIANGLE
DISPLAY SHELF**
L17" W17" | L44cm W44cm



S-CLS-HW-07

S-CLS-HG-07

S-CLS-HB-07

**SMALL TRIANGLE
DISPLAY SHELF**
L14" W14" | L35cm W35cm



S-SLF-HW-03

S-SLF-HG-03

S-SLF-HB-03

**LARGE OVAL
DISPLAY SHELF**
L20" W10" | L50cm W25cm

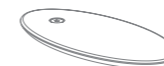

S-SLF-HW-04

S-SLF-HG-04

S-SLF-HB-04

**SMALL OVAL
DISPLAY SHELF**
L16" W8" | L40cm W20cm

MATERIAL GUIDE

Customize your Modular Stations by choosing from the different colors and finishes available. Simply choose your preferred design combination by inserting the corresponding letter to its designated space as demonstrated below.

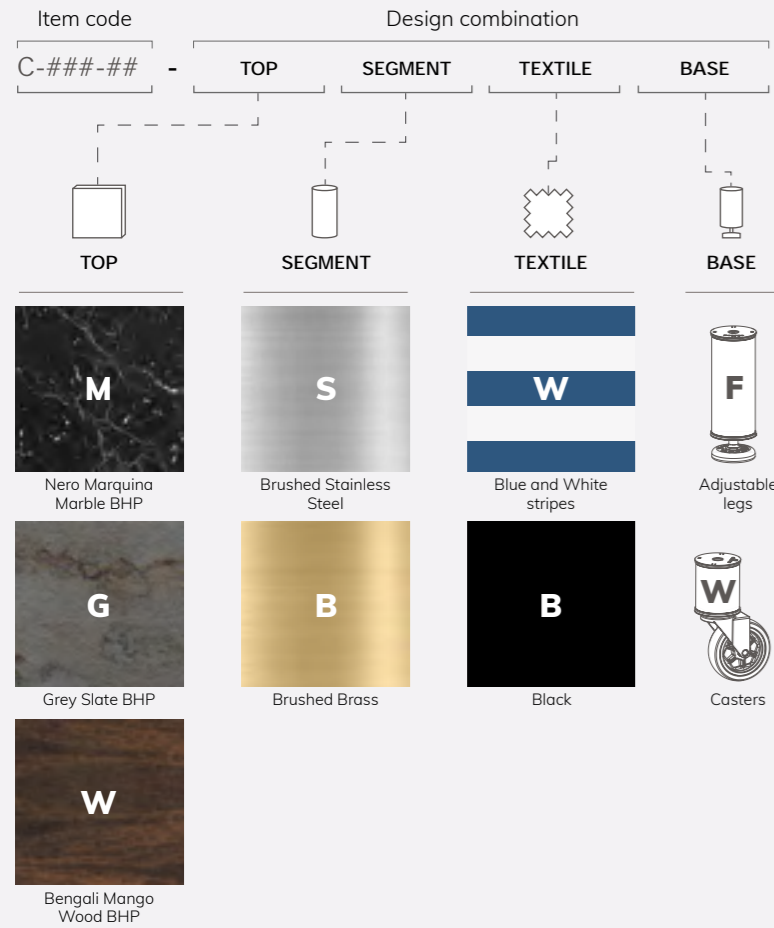

EXAMPLE:

C-MLB-10- G B W F =



CLASSIC RANGE STAINLESS STEEL SPECIAL TABLETOP KITS

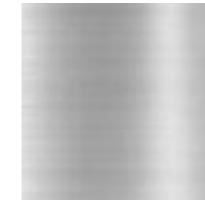

Brushed Stainless Steel

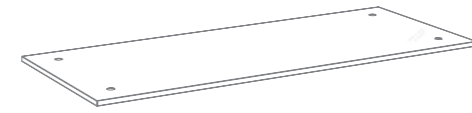

STAINLESS STEEL TOP
L71" W29.5"
L180cm W75cm

S-STP-SS-03

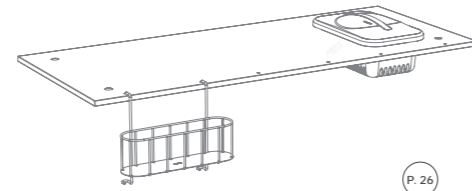

PRO BAR TOP
L71" W29.5" | L180cm W75cm
Ice Bin: L16" W9" D6"
L41.5cm W23cm D15cm

C-ITC-01-SXXX

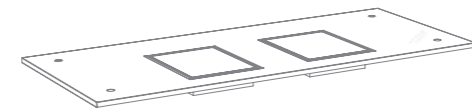

COOKING DROP-IN TOP
L71" W29.5"
L180cm W75cm

C-ITD-01-SXXX

CLASSIC RANGE STAINLESS STEEL SPECIAL TABLETOP UNITS

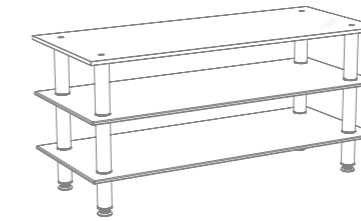

LARGE PRO UNIT
L71" W29.5" H35"
L180cm W75cm H88.5cm

C-MLA-05- _ _ X _

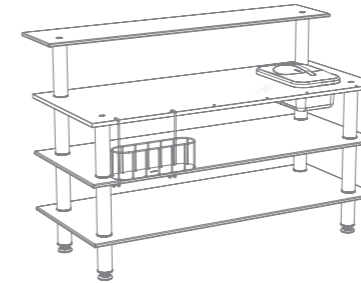

PRO BAR
L71" W29.5" H47.5"
L180cm W75cm H121cm

C-MLC-05- _ _ X _

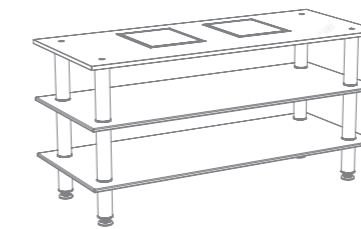

PRO COOKING INDUCTION
L71" W29.5" H35"
L180cm W75cm H88.5cm

C-MLD-01- _ _ X _

MATERIAL GUIDE

Customize your Modular Stations by choosing from the different colors and finishes available. Simply choose your preferred design combination by inserting the corresponding letter to its designated space as demonstrated below.

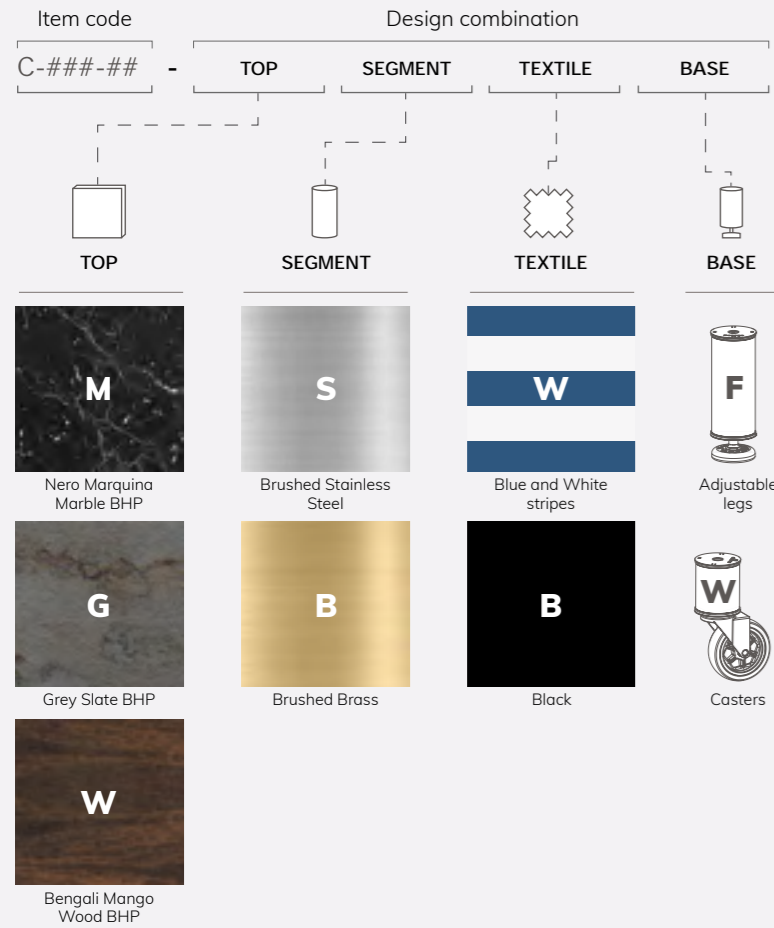

EXAMPLE:

C-MLB-10- G B W F =



CLASSIC RANGE SPECIAL TABLETOP KITS

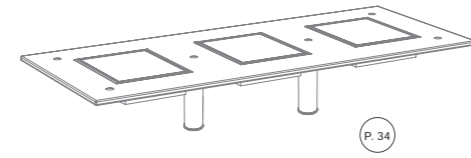

WARMING TRIPLE DROP-IN TOP
L71" W29.5" | L180cm W75cm
Comes with 2 x 12" support segment

C-ITD-02- __ XX

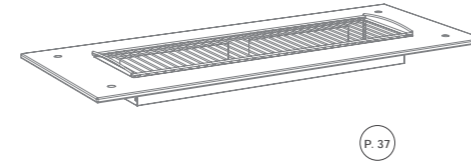

HEAT TABLETOP
L71" W29.5" | L180cm W75cm
Grill: L48" W25" D6.5"
L122cm W63cm D16cm

C-ITD-04- _ XXX

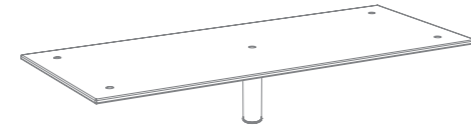

MID-HOLE DISPLAY TABLETOP
L71" W29.5" | L180cm W75cm
Comes with 1 x 12" support segment

C-ITB-01- __ XX

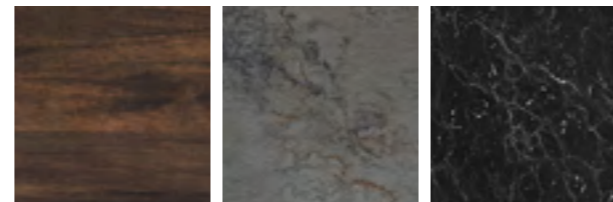

Bengali Mango
Wood BHP

Grey Slate BHP

Nero Marquina
Marble BHP

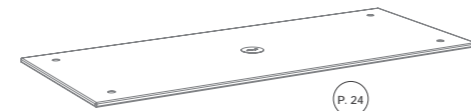

MARKET PANEL
(Only for Market Square)
L71" W29.5" | L180cm W75cm

S-STP-HW-05

S-STP-HG-05

S-STP-HB-05

CLASSIC RANGE SPECIAL TABLETOP UNITS

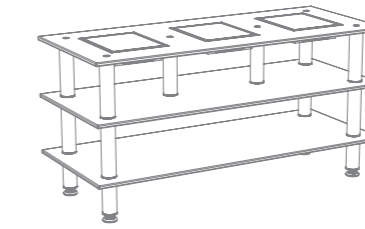

TRIPLE WARMING UNIT
L71" W29.5" H35"
L180cm W75cm H88.5cm

C-MLD-07- __ X _

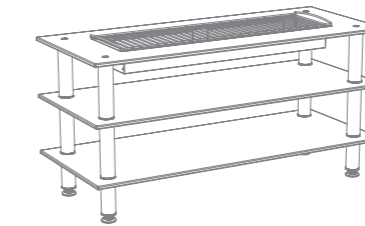

HEAT TABLE
L71" W29.5" H35"
L180cm W75cm H88.5cm

C-MLD-06- __ X _

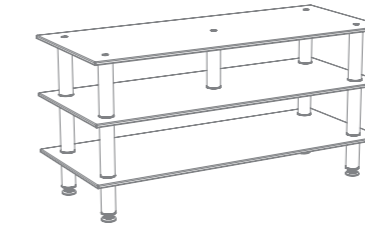

MID-HOLE DISPLAY UNIT
L71" W29.5" H35"
L180cm W75cm H88.5cm

C-MLB-09- __ X _



ROLLIN
SERVICE CARTS

mogogo



MIXOLOGY CART WITH LEATHER HANDLE C-RNX-03-GSXX
(shown with optional Charcoal-Black quick covers)

INDEX

4	About Mogogo
8	About Roll'n Collection
9	Materials
10	How It Works
12	Details
14	Cart configurations
24	System Breakdown



A MODULAR F&B
FURNITURE BRAND

BORN FROM A PASSION FOR **STYLE & GASTRONOMY**



Mogogo is led by designers and chefs that are aiming to introduce innovative, luxurious, and highly functional equipment to foodservice professionals.



LINENLESS



MODULAR



MOBILE



SUSTAINABLE



ADD ONS



FRESH LOCAL
MARKET
PRODUCE

CAMPARI
STOLICHNAYA

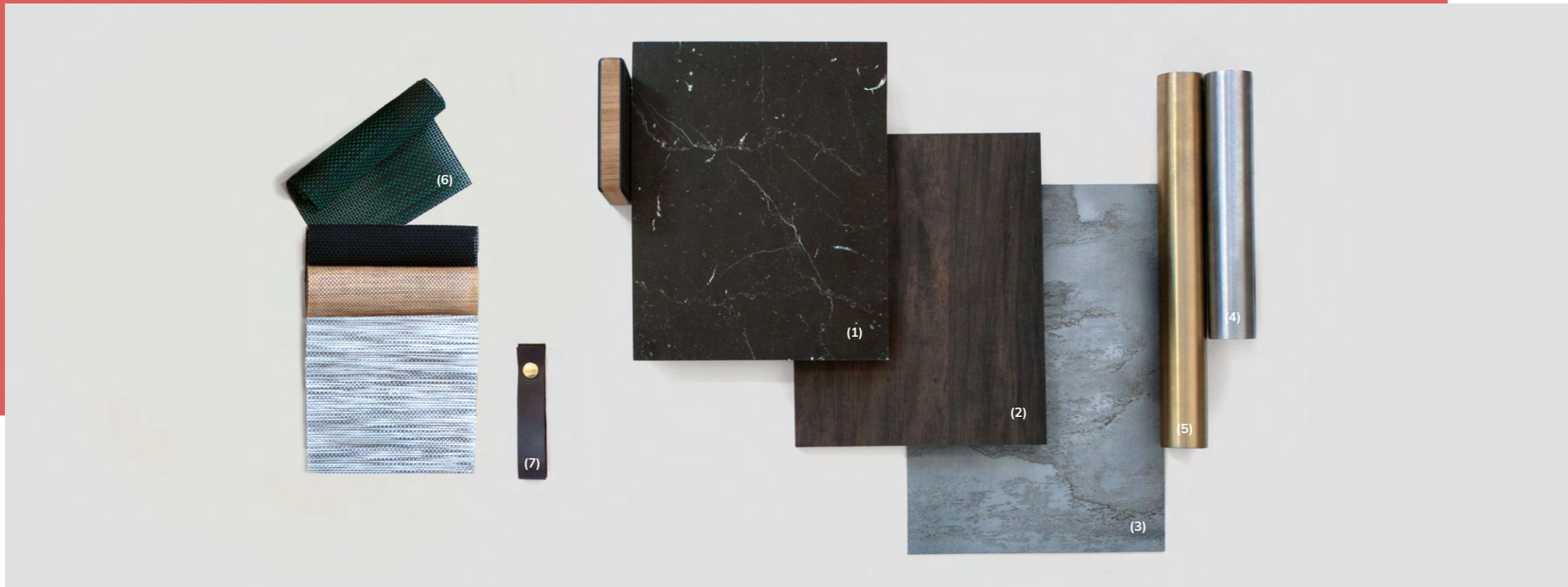

ABOUT THE ROLL'N COLLECTION

Service carts have been part of the hospitality industry for decades, a kind of smaller food cart used by restaurants and hotels to deliver or display food with style, while presenting chosen concepts to guests. Now back in fashion they have again become a must in food service.

Like everything designed by Mogogo, the Roll'n Service Cart collection starts with core elements that include elegance, function and durability, and when combined with a selection of add-ons and accessories, it converts into a cheese serving cart, cocktail cart, and much more. Now available with the options of a stainless handle and heavy-duty bumper, it rolls in style at any location.

MATERIALS

Style and durability were at the forefront in the selection of materials for the Roll'n collection our innovative BHP shelves, a composed material merging layers of High-Pressure Laminate with a Bamboo core, to create a lighter yet durable panel. These BHP Finishes resemble natural materials such as Nero Marquina Marble, Bengali Mango Wood, and Grey Slate (1-3). In addition, the Roll'n segments (legs) come in brushed stainless steel (4) and brushed brass (5) finish. Easily cover the shelves on your cart with our original quick covers (6). Durable and easy to clean, they are available in four color options. You can also choose between the luxurious hand-stitched genuine leather (7) handle, or the very durable and easy to clean stainless steel (4) handle.

HOW IT WORKS

Delivered in flat packaging, the Roll'n Service Cart is designed for effortless assembly. With a multi-purpose cart in mind, Mogogo's Service Cart was developed alongside a series of add-ons that can easily transform your standard service cart into a cheese serving cart, wine cart, cocktail cart, and more. Functionality is key when it comes to the daily challenges of Food & Beverage professionals. For this specific reason, Mogogo's quick-covers are essential to quickly conceal the two lower layers for dishes or additional items you would like to hide from your guests in the most elegant way.

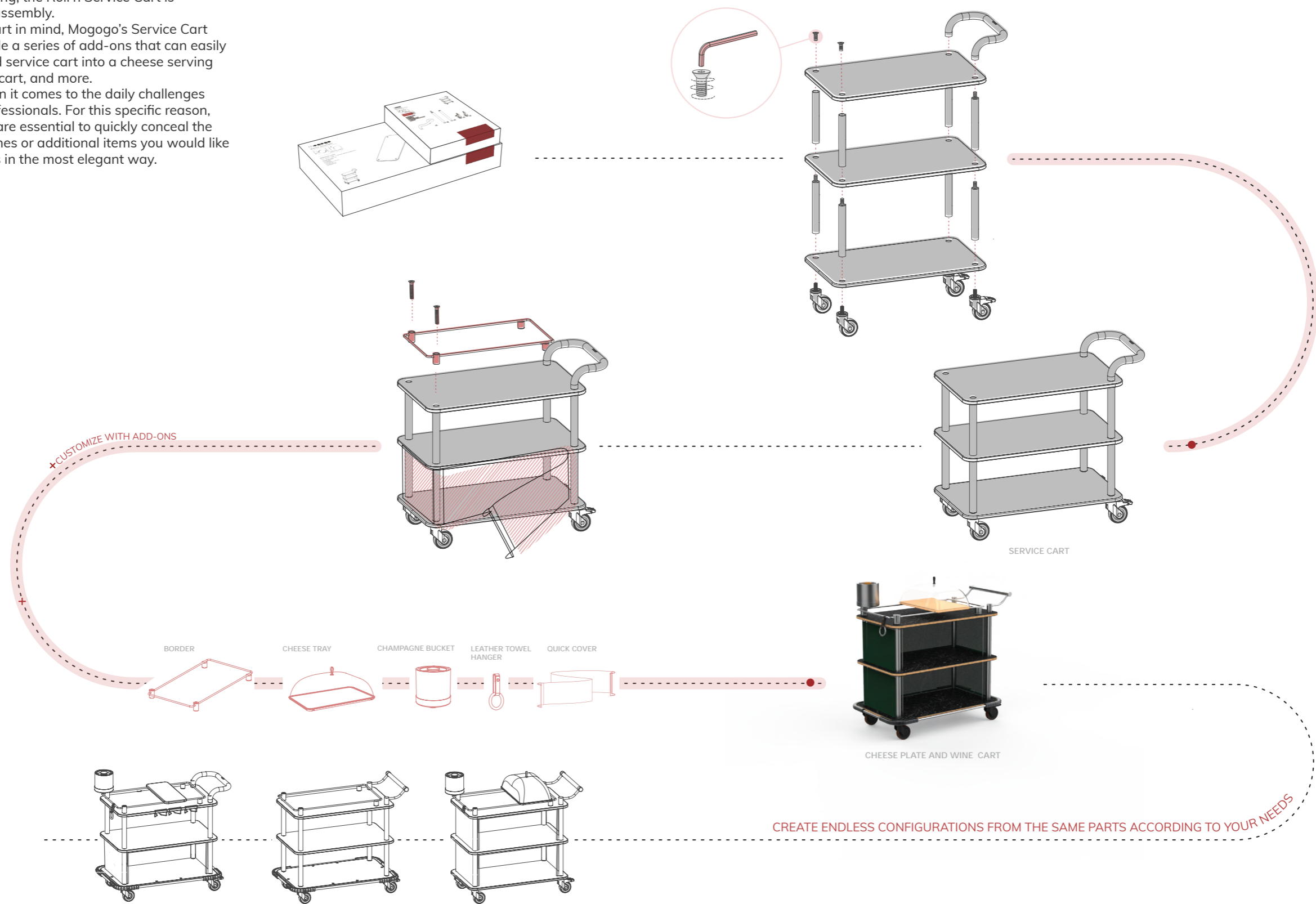

DETAILS



MATERIAL GUIDE

Customize your Roll'n Service Carts by choosing from the different colors and finishes available. Simply choose your preferred design combination by inserting the corresponding letter to its designated space as demonstrated below.

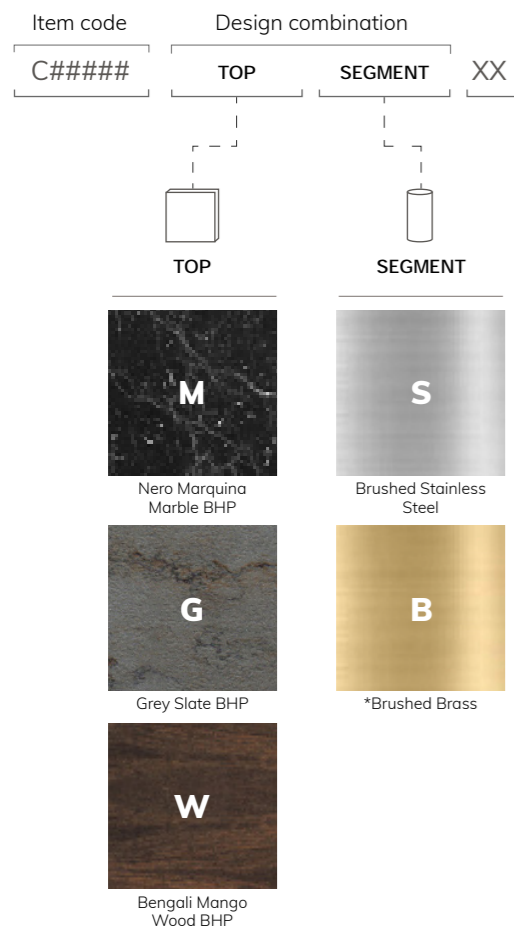

*Brass finish isn't available in configuration with stainless steel handle.

EXAMPLE:
C-RNX-01-MSXX

=



SERVICE CART WITH LEATHER HANDLE

Our original Roll'n service cart with the hand-stitched genuine leather handle is iconic, adding sensuality and warmth, and loved by both staff and guests. The basic configuration is slick and can easily transform into a variety of conceptual configurations.

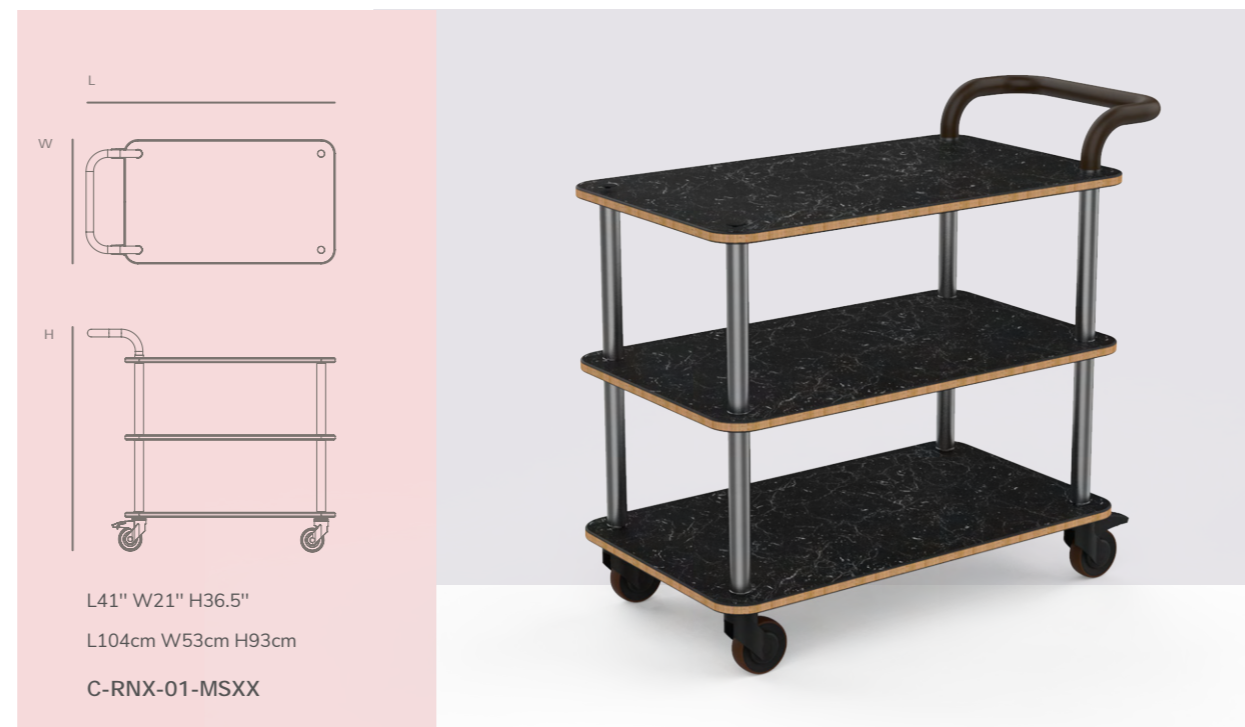

MORE CONFIGURATIONS



TOP BORDER CART
WITH LEATHER HANDLE
C-RNX-02-GSXX

MIXOLOGY CART
WITH LEATHER HANDLE
C-RNX-03-MSXX

(shown with optional Silver-grey quick covers)

CHEESE PLATE & WINE CART
WITH LEATHER HANDLE
C-RNX-04-WSXX

(shown with optional Jungle-Green quick covers)



CHEESE PLATE & WINE CART WITH LEATHER HANDLE
C-RNX-04-MSXX

(shown with optional Charcoal-Black quick covers)

The iconic Roll'n Service Cart is customized with a border, cheese tray, leather towel hanger and champagne bucket.

MATERIAL GUIDE

Customize your Roll'n Service Carts by choosing from the different colors and finishes available. Simply choose your preferred design combination by inserting the corresponding letter to its designated space as demonstrated below.

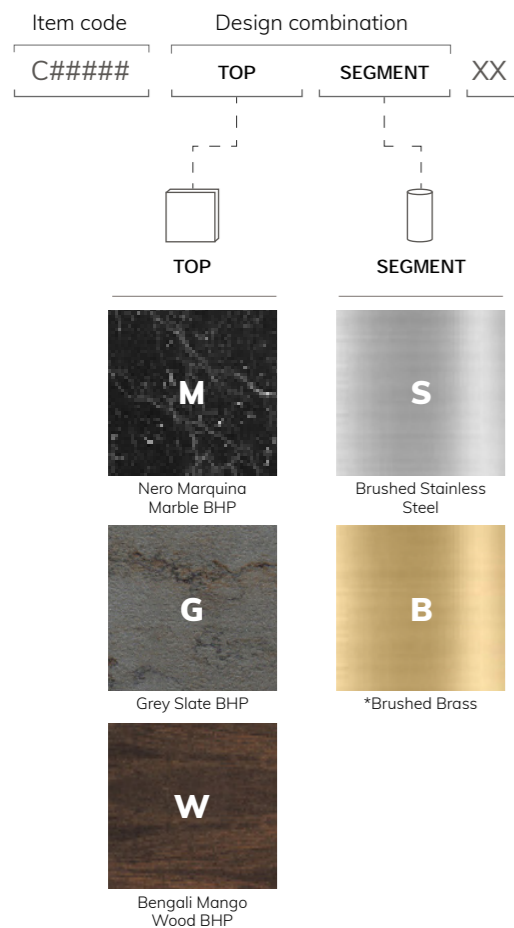

*Brass finish isn't available in configuration with stainless steel handle.

EXAMPLE:
C-RNX-01-MSXX

=



SERVICE CART WITH STAINLESS STEEL HANDLE*

This new addition to the Roll'n collection comes with a stainless steel handle and is ideal for use in harsher environments.

*Brass finish is not available with the stainless steel handle models

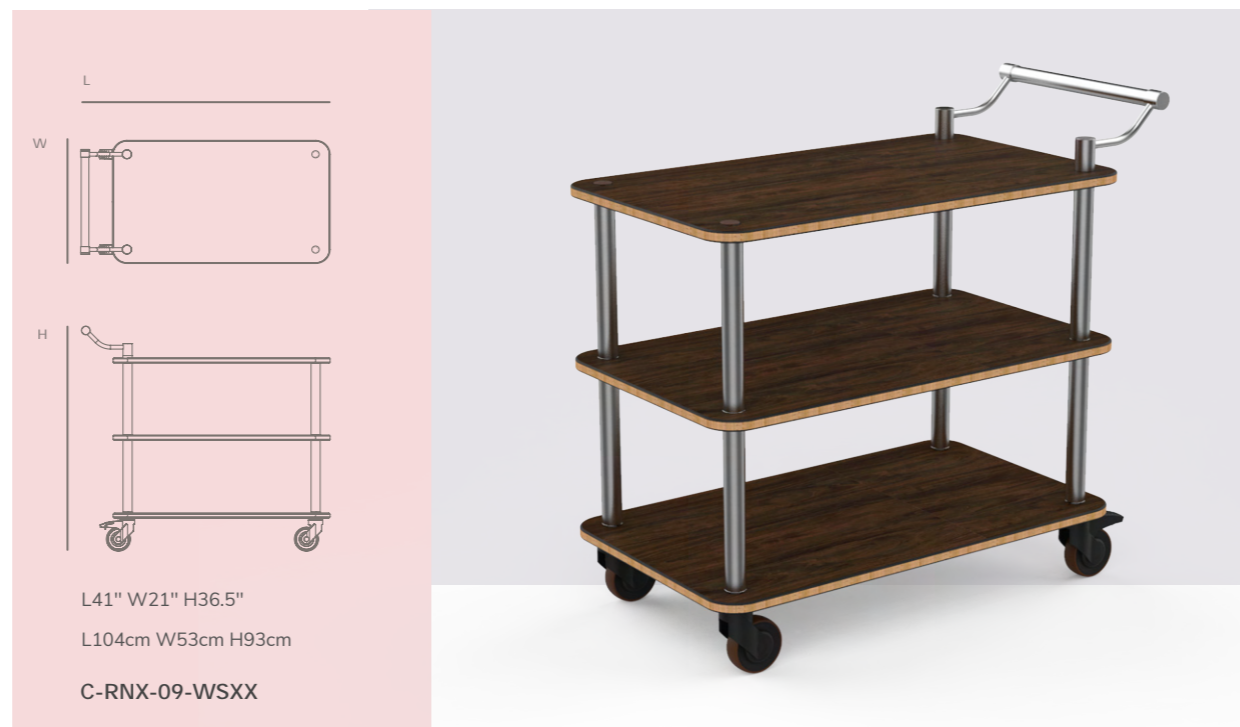

MORE CONFIGURATIONS



TOP BORDER CART
WITH STAINLESS STEEL HANDLE
C-RNX-15-WSXX

(shown with optional Golden-brown quick covers)



MIXOLOGY CART
WITH STAINLESS STEEL HANDLE
C-RNX-16-MSXX



CHEESE PLATE & WINE CART
WITH STAINLESS STEEL HANDLE
C-RNX-17-GSXX

(shown with optional Jungle-Green quick covers)



SERVICE CART WITH STAINLESS STEEL HANDLE
C-RNX-09-GSXX

MATERIAL GUIDE

Customize your Roll'n Service Carts by choosing from the different colors and finishes available. Simply choose your preferred design combination by inserting the corresponding letter to its designated space as demonstrated below.

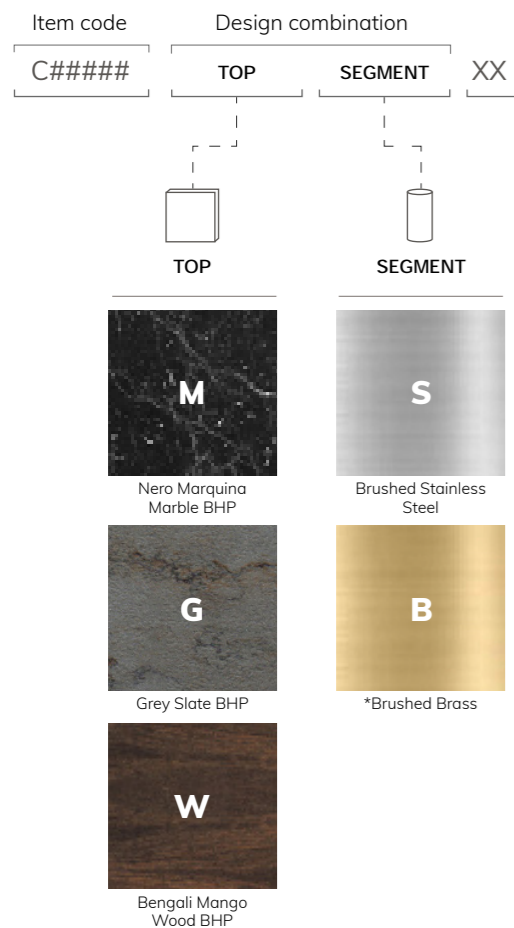

*Brass finish isn't available in configuration with stainless steel handle.

EXAMPLE:
C-RNX-01-MSXX

=



SERVICE CART WITH LEATHER HANDLE AND HEAVY DUTY BUMPER

We've added a heavy-duty bumper to our carts for those applications where elegance meets the need for additional protection.

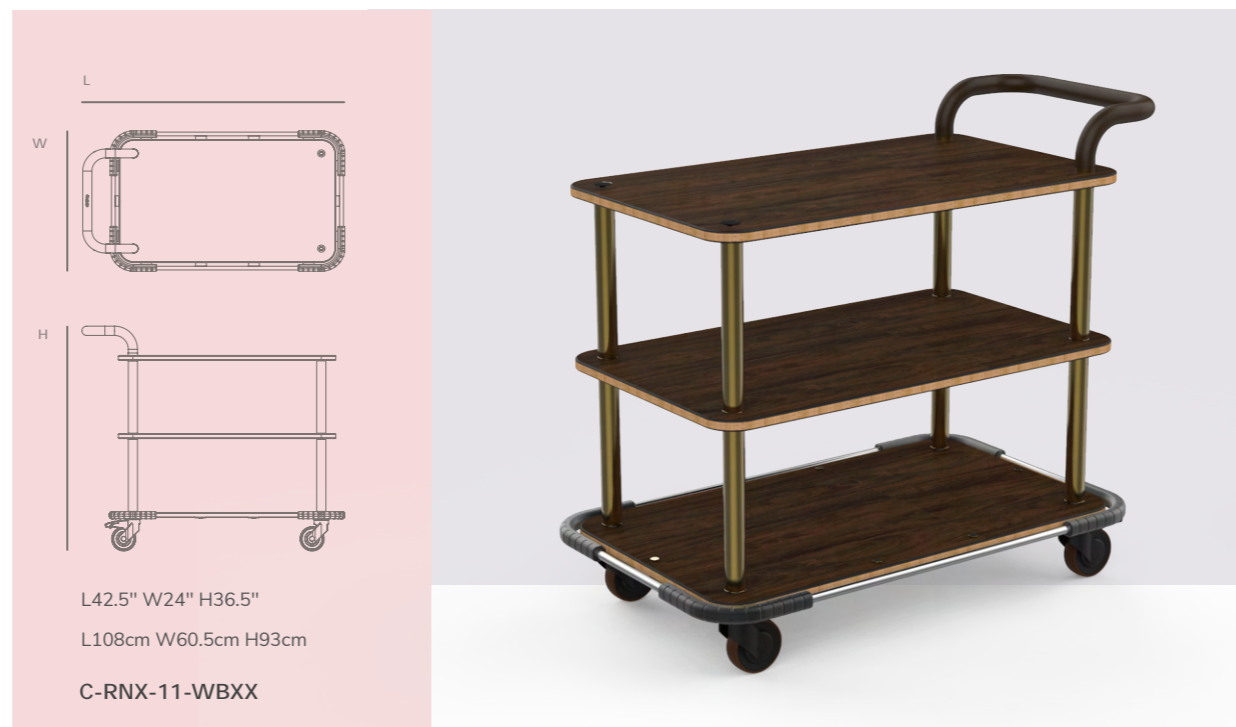

MORE CONFIGURATIONS



TOP BORDER CART WITH LEATHER HANDLE AND HEAVY DUTY BUMPER
C-RNX-08-GBXX

(shown with optional Jungle-Green quick covers)



MIXOLOGY CART WITH LEATHER HANDLE AND HEAVY DUTY BUMPER
C-RNX-13-WSXX

(shown with optional Golden-brown quick covers)



CHEESE PLATE & WINE CART WITH LEATHER HANDLE AND HEAVY DUTY BUMPER
C-RNX-14-MSXX

(shown with optional Silver-grey quick covers)



MIXOLOGY CART WITH LEATHER HANDLE AND HEAVY DUTY BUMPER
C-RNX-13-WSXX

(shown with optional Silver-grey quick covers)

Make drinks indoors and out with this tough and stylish cart, which comes equipped with a stainless steel handle, cutting board, top border, ice bucket and glass racks.

MATERIAL GUIDE

Customize your Roll'n Service Carts by choosing from the different colors and finishes available. Simply choose your preferred design combination by inserting the corresponding letter to its designated space as demonstrated below.

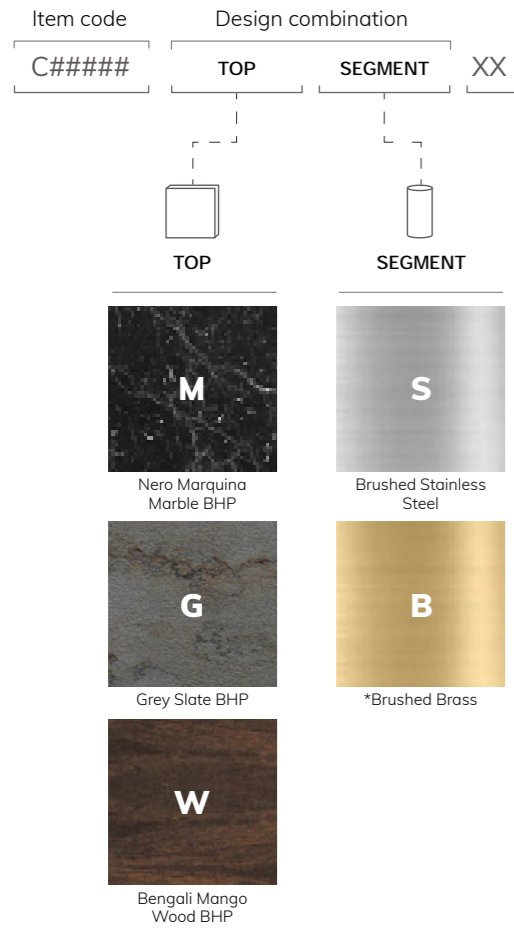

*Brass finish isn't available in configuration with stainless steel handle.

EXAMPLE:

C-RNX-01-MSXX

=



SERVICE CART WITH STAINLESS STEEL HANDLE AND HEAVY DUTY BUMPER*

Our foremost durable cart comes with a stainless handle and heavy-duty bumper, designed to operate under intense use in harsh environments.

*Brass Finish is not available with stainless steel handle models



MORE CONFIGURATIONS



TOP BORDER CART
WITH STAINLESS STEEL HANDLE
AND HEAVY DUTY BUMPER
C-RNX-18-MSXX

(shown with optional Jungle-Green quick covers)



MIXOLOGY CART
WITH STAINLESS STEEL HANDLE
AND HEAVY DUTY BUMPER
C-RNX-19-GSXX

(shown with optional Silver-grey quick covers)



CHEESE PLATE & WINE CART
WITH STAINLESS STEEL HANDLE
AND HEAVY DUTY BUMPER
C-RNX-20-WSXX



TOP BORDER CART WITH STAINLESS STEEL HANDLE AND HEAVY DUTY BUMPER

C-RNX-18-GSXX

(shown with optional Silver-grey quick covers)

With a stainless steel handle, heavy-duty bumper and top border, this cart is all about performance but with style in mind. The top border keeps goods in place while also acting as the platform to change the function with add-ons.

STYLE ON WHEELS





SYSTEM BREAKDOWN

The Roll'n System Breakdown consists of panels available in four finishes, leg segments available in two finishes, and an ever-expanding collection of functional accessories. This wide selection gives you the freedom to design your own cart depending on your specific needs or transform your existing basic cart into a Cheese & Wine or Mixology Cart.

MOGOGO TOOLS

	1 piece	ALLEN KEY FOR M16	S-AUX-SS-01
	1 piece	M16 SCREWS	S-CWM-T-01
	1 piece	FLAT WRENCH	S-SCM-SS-03
 	1 piece	BLACK SCREW CAP	S-SAC-PL-06
 	1 piece	GREY SCREW CAP	S-SAC-PL-05
 	1 piece	BROWN SCREW CAP	S-SAC-PI-02

MATERIAL GUIDE

Customize your Roll'n Service Carts by choosing from the different colors and finishes available. Simply choose your preferred design combination by inserting the corresponding letter to its designated space as demonstrated below.

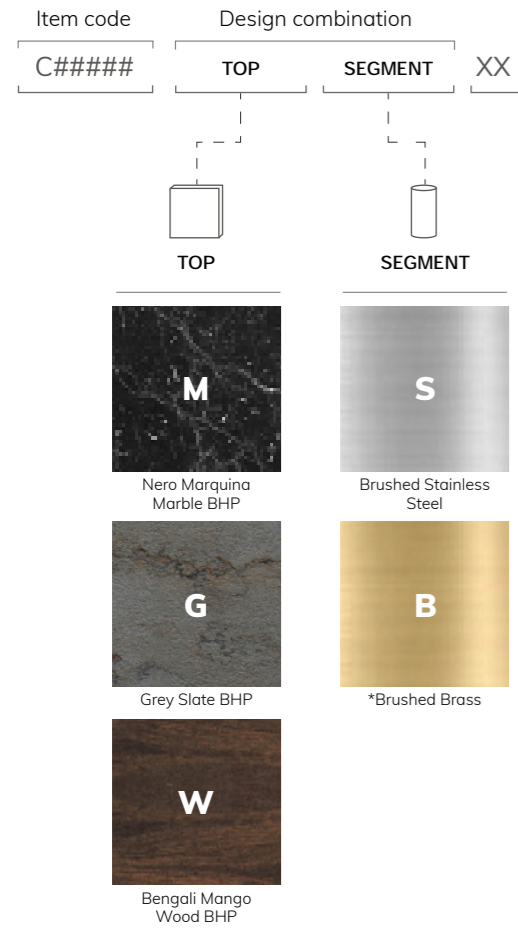

*Brass finish isn't available in configuration with stainless steel handle.

EXAMPLE:
C-RNX-01-MSXX

=



SERVICE CARTS



SERVICE CART WITH LEATHER HANDLE

L41" W21" H36.5"
L104cm W53cm H93cm

C-RNX-01 __ XX



SERVICE CART WITH STAINLESS STEEL HANDLE

L41" W21" H36.5"
L104cm W53cm H93cm

C-RNX-09 __ XX

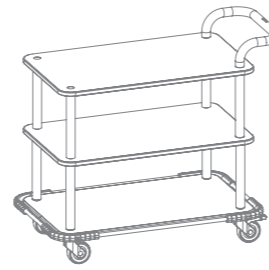

SERVICE CART WITH LEATHER HANDLE AND HEAVY DUTY BUMPER

L42.5" W24" H36.5"
L108cm W60.5cm H93cm

C-RNX-11 __ XX



SERVICE CART WITH STAINLESS STEEL HANDLE AND HEAVY DUTY BUMPER

L42.5" W24" H36.5"
L108cm W60.5cm H93cm

C-RNX-12 __ XX

QUICK COVERS

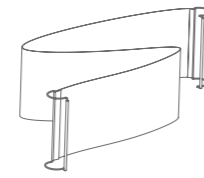

SERVICE CART QUICK COVERS
2 per box



SERVICE CART STORAGE COVERS
2 per box

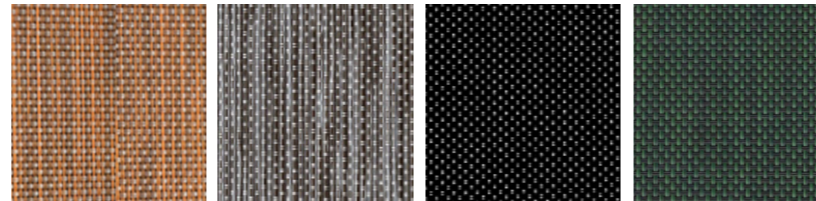

Golden-Brown

Silver-Grey

Charcoal-Black

Jungle-Green

S-QCO-PV-13-01

S-QCO-PV-14-01

S-QCO-PV-21-01

S-QCO-GP-07-01

S-QCO-PV-29-01

S-QCO-PV-3601

S-QCO-PV-37-01

S-QCO-GP-12-01

ADD-ONS

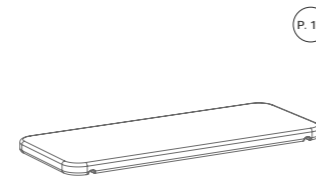

CUTTING BOARD
L19" W8" H0.7"
L49cm W20cm H2cm
fits Border

S-SCM-BM-02-01

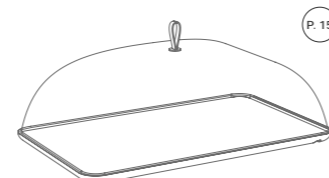

CHEESE TRAY
L19" W12" H7"
L49cm W30cm H17cm
fits Border

S-SCM-BM-05-01

ADD-ONS

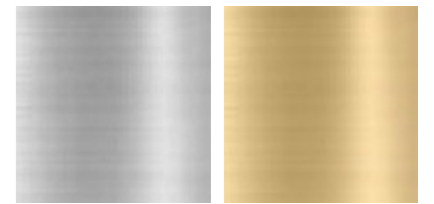

Brushed Stainless Steel

Brushed Brass

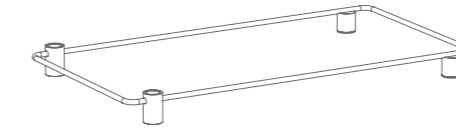

BORDER
L31.5" W17" H2"
L80cm W44cm H5cm
fits service cart

S-SCM-SS-04-01

S-SCM-BR-01-01



LEATHER TOWEL HANGER
fits Border

S-SCM-SL-01-01

S-SCM-SL-02-01



WINE GLASS HOLDER
L21" W4" H2"
L53cm W11cm H5.5cm
Holds up to 6 wine glasses

S-SCM-SS-05-01

S-SCM-BR-06-01

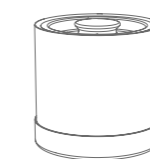

ICE / CHAMPAGNE BUCKET
Ø6" H6"
Ø15.5cm H15.5cm
fits Border

S-SCM-SS-06-01

-/-



POLO
TABLES

mogogo



SQUARE BISTRO TABLE C-PRS-01-WSXX \ \ **ROUND BISTRO TABLE** C-PRR-01-MSXX

INDEX



A PROFESSIONAL
FOOD & BEVERAGE
FURNITURE COMPANY

BORN A PASSION FOR Style & Gastronomy



Mogogo is led by designers and chefs that are aiming to introduce innovative, luxurious, and highly functional equipment to foodservice professionals.

A PERFECT BALANCE
OF LUXURY AND FUNCTION



LINENLESS



MODULAR



MOBILE



SUSTAINABLE



ADD ONS





ABOUT POLO COLLECTION

Mogogo's PoLo Tables are lightweight and extremely versatile, designed using our unique Modular System.

Available in Round, Square, or Oval Tabletop shapes, they offer a wide variety of combinations.

This approach allows for the same coffee table to be effortlessly transformed into a bistro or bar table and then into a champagne or dessert station in no time. It provides you with flexibility while also retaining simplicity and style.

MATERIALS

PoLo tops are made of our innovative BHP material. BHP is a newly composed material that arrived after two years of intense R&D. It merges layers of High-Pressure Laminate with a Vertical Bamboo core (Mogogo's expertise) creating a lighter yet durable panel that offers new textures and colors. This new material combines the advantages of both bamboo and HPL, perfect for the ever-changing needs of the hospitality industry. Available in a variety of finishes that resemble natural materials such as Bengali Mango Wood, Nero Marquina Marble, and Grey Slate (1-3), making it easy to match with any event and decor.

The innovative bamboo core of the BHP goes in line with Mogogo's sustainability motto while the HPL's outer coating is durable for different environments, hygienic, and easy to clean.

PoLo segments come in 2 finishes- brushed stainless steel (4) and brushed brass (5).

HOW IT WORKS

Mogogo's PoLo Tables' industrial design is based on the Modular System. Delivered to you in flat packaging, it is easy and fast to assemble & disassemble. Composed of the same individual components (tabletops, leg segments, and mid-part segments) it gives you the flexibility to transform the same coffee table into a bistro table, a bar table, or a display table.

PoLo's cross base and adjustable legs give it stability and the flexibility to adapt your table to any terrain. The clean one pole design makes this table blend easily into any design scheme and event space.

Highly versatile while offering durability and functionality, PoLo Tables enable you to use your creativity. Play with heights, tabletop shapes (round, square, or oval), different finishes, and add shelving layers as needed for additional display.

FLAT PACK PACKAGING

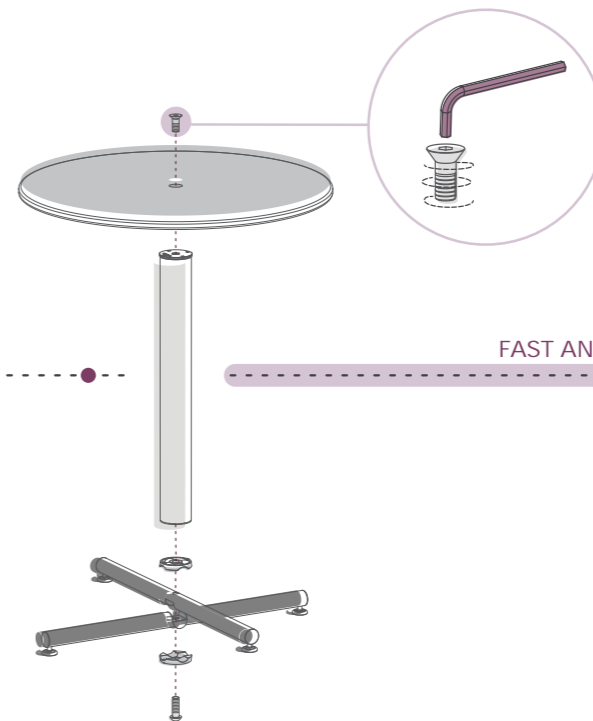
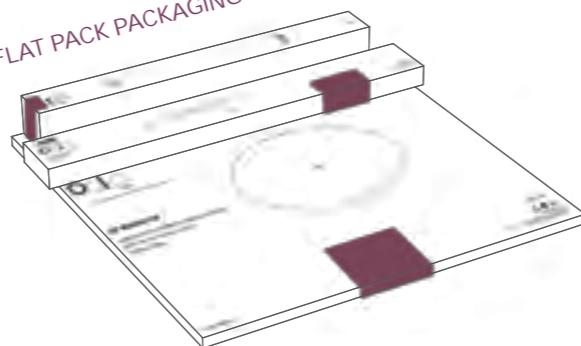

FAST AND EASY ASSEMBLY

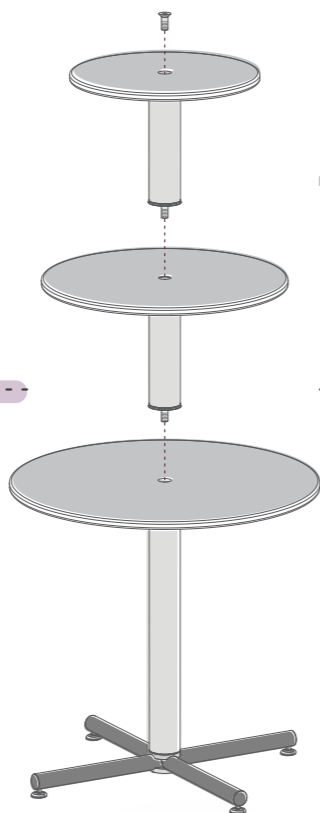

ROUND DISPLAY TABLE

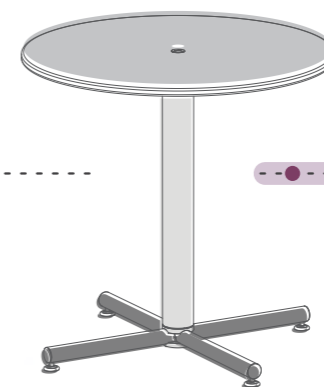

ROUND BISTRO TABLE

MIX AND MATCH



POLO TABLES
COFFEE / DISPLAY / BISTRO

ADAPTS TO ANY OCCASION.



C-PPS-01-WBXX



C-PRR-01-MBXX



C-PFV-01-MSXX

COLOR COMBINATIONS



C-PBR-01-GBXX

Different colors, shapes, and heights make the PoLo table perfect for multiple combinations and styles. Completely transform the atmosphere of your event by changing the tables' heights. From bar to bistro to coffee tables, try a combination to maximize space.



C-PFV-01-MSXX



*
Mix Nero Marquina Marble finish with brass for an elegant, classy look, while Grey Slate with stainless gives it an urban and outdoor feel.



C-PBS-02-WSXX





OVAL COFFEE TABLE C-PFV-01-WSXX



COFFEE TABLES

In addition to being lightweight, quickly assembled, and versatile while offering durability, Mogogo Coffee Tables can be placed anywhere in the room, for both decorative and service purposes.

Combined with other available heights and tabletop shape options, you can create interesting visual variations in elevations to further add to your stylish display.

MATERIAL GUIDE

Customize your PoLo Tables by choosing from the different colors and finishes available. Simply choose your preferred design combination by inserting the corresponding letter to its designated space as demonstrated below.

Item code: C-###-##
 Design combination: TOP SEGMENT XX



TOP



SEGMENT

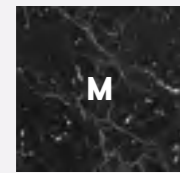

Nero Marquina
Marble BHP



Brushed Stainless
Steel

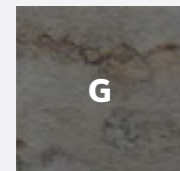

Grey Slate BHP

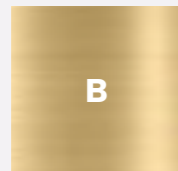

Brushed Brass

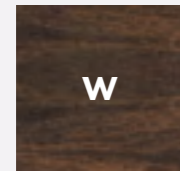

Bengali Mango
Wood BHP

EXAMPLE:

C-PBR-01- M S XX =



ROUND COFFEE TABLE

Beautiful round coffee table for any small and intimate setup.

C-PFR-01- W S XX



SQUARE COFFEE TABLE

An elegant and stylish squared coffee table that will fit perfectly in any setup.

C-PFS-01- M B XX



OVAL COFFEE TABLE

Ideal oval shaped top that is bigger in size, making it perfect for a lounge or food display.

C-PFV-01- G S XX



SQUARE BISTRO TABLE C-PRS-01-WBXX

BISTRO TABLES

The 30" (76 cm) table is the most common height and diameter utilized for dining tables in the hospitality industry. Available in both round and square tabletop shapes, the Mogogo PoLo Tables unique modular system allows to be transformed into a highboy or three-tier dessert station in just a few steps.

Mogogo Bistro Tables are designed for a lightweight, stylish, and clean look, in addition to their flexible and functional properties.

MATERIAL GUIDE

Customize your PoLo Tables by choosing from the different colors and finishes available. Simply choose your preferred design combination by inserting the corresponding letter to its designated space as demonstrated below.

Item code: C-###-##
 Design combination: TOP SEGMENT XX



TOP



SEGMENT

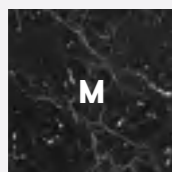

Nero Marquina Marble BHP



Brushed Stainless Steel

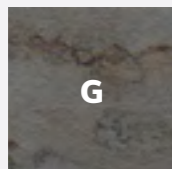

Grey Slate BHP

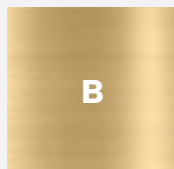

Brushed Brass

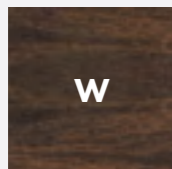

Bengali Mango Wood BHP

EXAMPLE:

C-PBR-01- M S XX =



ROUND BISTRO TABLE

Ultimate round top dining table for any hospitality setting, with perfect height making it accessible.

C-PRR-01- G S XX



SQUARE BISTRO TABLE

Square dining table, the perfect size that fits any venue or display.

C-PRS-01- W B XX



SQUARE BISTRO TABLE C-PRS-01-WBXX \ \ OVAL COFFEE TABLE C-PFV-01-WBXX



ROUND BAR TABLE C-PBR-01-MSXX \ \ **SQUARE BAR TABLE + SHELF** C-PBS-02-GSXX

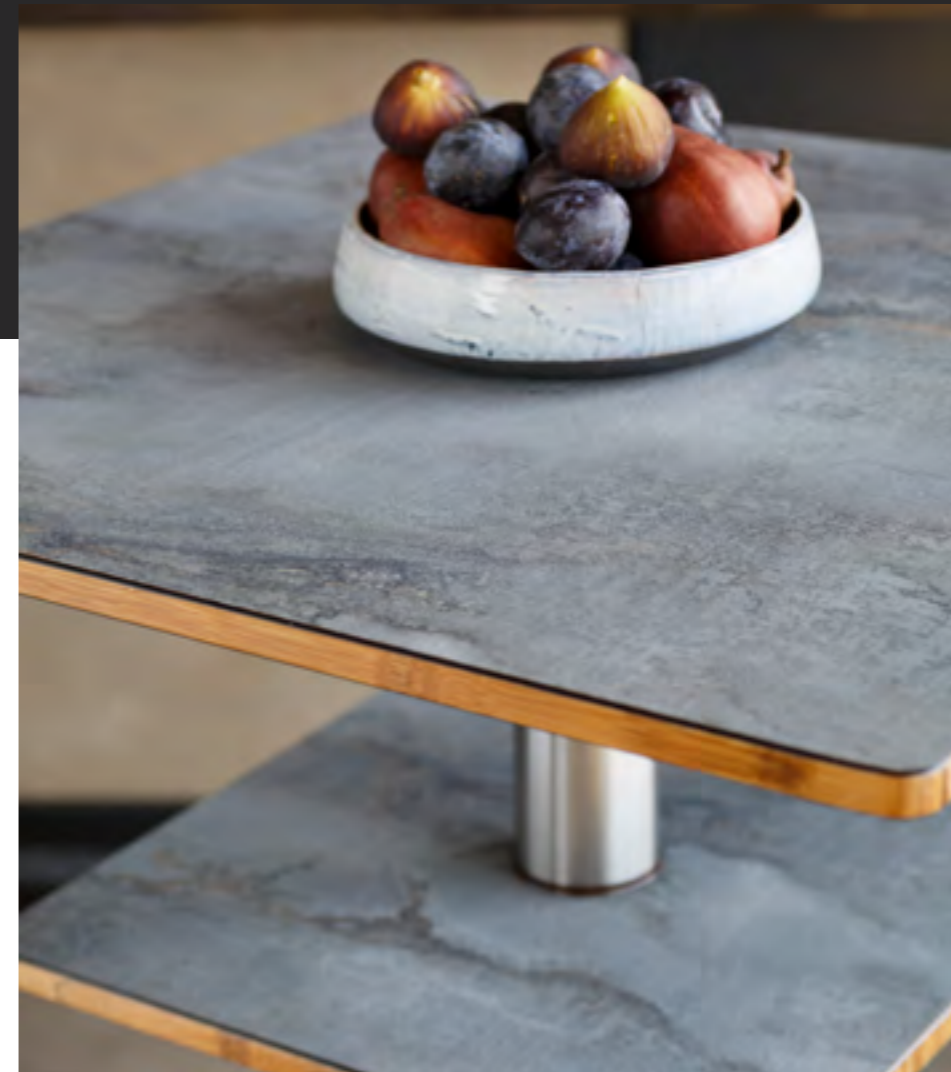

BAR TABLES

Mogogo Bar Tables consist of Round or Square Tabletops and elongated bases made of brushed stainless steel or brushed brass finish.

In addition to being sleek and eye-catching from anywhere in the room, these tables are highly sturdy and can be used in a number of ways. Additionally, can be placed near different height round or square tables for a unique take on serving drinks or delicacies.

MATERIAL GUIDE

Customize your PoLo Tables by choosing from the different colors and finishes available. Simply choose your preferred design combination by inserting the corresponding letter to its designated space as demonstrated below.

Item code: C-###-##
 Design combination: TOP SEGMENT XX



TOP



SEGMENT

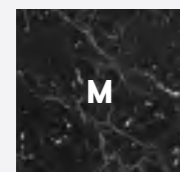

M

Nero Marquina
Marble BHP



S

Brushed Stainless
Steel

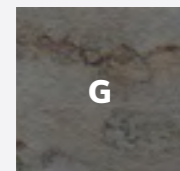

G

Grey Slate BHP

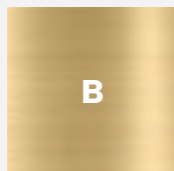

B

Brushed Brass

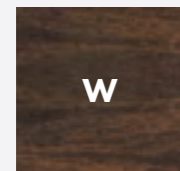

W

Bengali Mango
Wood BHP

EXAMPLE:

C-PBR-01- M S XX =



ROUND BAR TABLE

Easily portable round top that completes any fancy cocktail party.

C-PBR-01- W S XX



SQUARE BAR TABLE

Square bar table that looks fantastic in every social gathering.

C-PBS-01- G S XX



ROUND BAR TABLE + SHELF

Perfect round bar table with added lower shelf for modularity and style.

C-PBR-02- M B XX

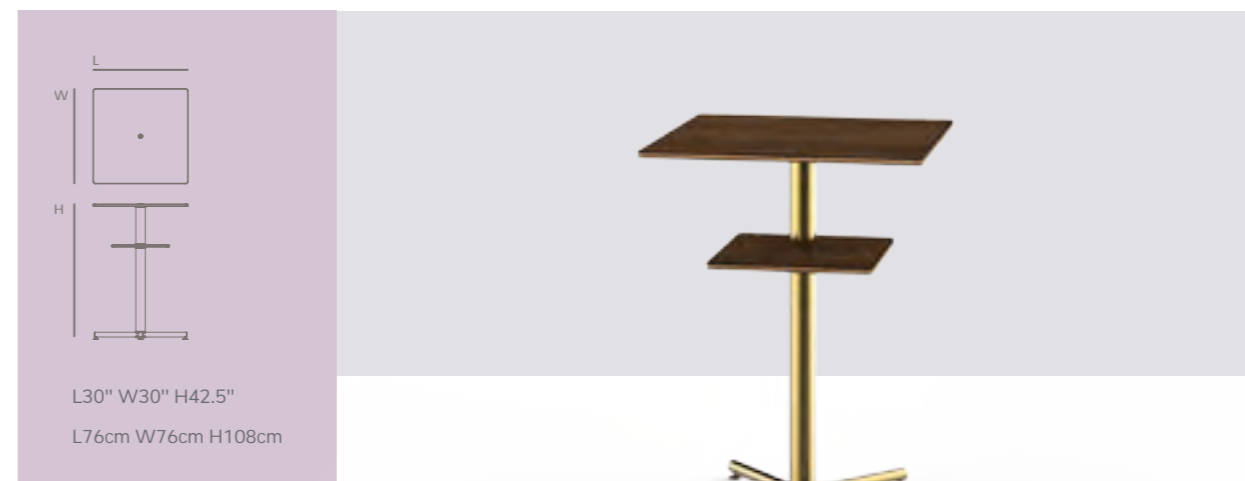

SQUARE BAR TABLE + SHELF

Refined Square bar table with a shelf that is great to expose food or beverage in a unique way.

C-PBS-02- W B XX

DAY & NIGHT

PoLo Tables fit in your morning coffee lounge just as well as they do in elegant evening events.



ROUND COFFEE TABLE C-PFR-01-GSXX



ROUND DISPLAY TABLE C-PPR-01-WBXX



ROUND DISPLAY TABLE C-PPR-01-MBXX



DISPLAY TABLES

Celebrate in style with these elegant Round or Square Top Display Tables.

Create an artistic design to help enrich and elevate the way you serve. Choose this table in order to show off a divine selection of hors-d'oeuvres, wine, mixed drinks, or any type of finger food.

With an elevated base and impressive decoration, Mogogo Display Tables are visible from anywhere in the room and can serve desserts, champagne, or anything else you would like to bring to the attention of your guests.

MATERIAL GUIDE

Customize your PoLo Tables by choosing from the different colors and finishes available. Simply choose your preferred design combination by inserting the corresponding letter to its designated space as demonstrated below.

Item code: C-###-##
 Design combination: TOP SEGMENT XX



TOP



SEGMENT

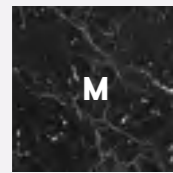

M
Nero Marquina
Marble BHP



S
Brushed Stainless
Steel

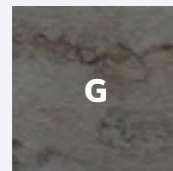

G
Grey Slate BHP

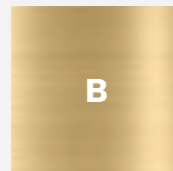

B
Brushed Brass

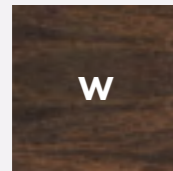

W
Bengali Mango
Wood BHP

EXAMPLE:

C-PBR-01- M S XX =



ROUND DISPLAY TABLE

Graceful round display table with two shelves that adds a special touch to all your food and beverages.

C-PPR-01- M B XX



SQUARE DISPLAY TABLE

Classic yet fashionable square display table with two shelves that complete any display beautifully.

C-PPS-01- G S XX



SQUARE DISPLAY TABLE C-PPS-01-GSXX

TRANSFER & STORAGE CARTS

Mogogo's utility carts are designed for your convenience and mobility and are an integral part of the PoLo system as they make storing and assembling the tables easy. Whether it is to pull out the tabletops, to push them through the halls, or get in and out of elevators; they make the behind the scenes of your time-sensitive events easier and give you an extra push on productivity.



**SEGMENTS AND ADD-ONS
TRANSFER AND STORAGE CART**
L55.5" W31" H50"
L141cm W79cm H127.5cm
holds segments and cross bases for 15 PoLo tables

C-UUX-01-XXXX

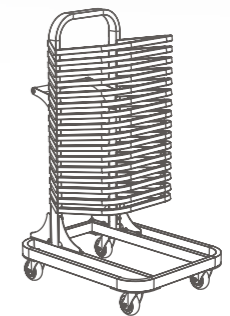

**ROUND / SQUARE TOP
TRANSFER AND STORAGE CART**
L40" W31" H61"
L101cm W79cm H155cm
holds up to 16 PoLo round/square tops

C-UUX-04-XXXX



SYSTEM BREAKDOWN

Mogogo's PoLo Table Collection is composed of three different shapes of tabletops: round, square and oval. different sizes of leg segments available in two finishes and optional smaller shelves in corresponding shapes.

Three types of parts; endless possibilities and table functions.

UTILITY KIT



ALLEN KEY FOR M16
2 M16 SCREWS
4 SCREW CAPS

S-SAC-SM-01

LEGS

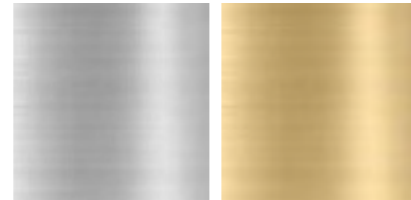

Brushed Stainless Steel Brushed Brass

S-POL-SS-03 S-POL-BR-03

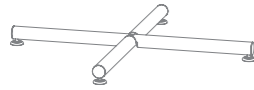

CROSS BASE
30" | 76cm



12" SEGMENT
H12" | H30cm

S-LEG-SS-01 S-LEG-BR-03



15" SEGMENT
H15" | H38cm

S-POL-SS-01 S-POL-BR-01



26" SEGMENT
H26" | H67cm

S-POL-SS-02 S-POL-BR-02

TOPS

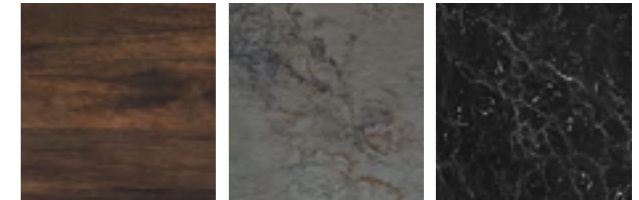

Bengali Mango Wood BHP Grey Slate BHP Nero Marquina Marble BHP

S-CRT-HW-01 S-CRT-HG-01 S-CRT-HB-01

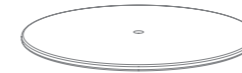

30" ROUND TOP
Ø30" | Ø76cm

S-CRT-HW-02 S-CRT-HG-02 S-CRT-HB-02



24" ROUND TOP
Ø24" | Ø60cm

S-CRT-HW-03 S-CRT-HG-03 S-CRT-HB-03



18" ROUND TOP
Ø18" | Ø46cm

S-POL-HW-04 S-POL-HG-04 S-POL-HB-04

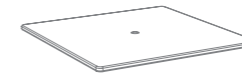

30" SQUARE TOP
30" | 76cm

S-POL-HW-03 S-POL-HG-03 S-POL-HB-03

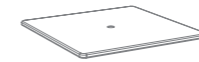

24" SQUARE TOP
24" | 60cm

S-POL-HW-02 S-POL-HG-02 S-POL-HB-02

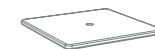

18" SQUARE TOP
18" | 46cm

S-POL-HW-01 S-POL-HG-01 S-POL-HB-01



42.5" OVAL TOP
L42.5" W30" | L108cm W76cm



DiX
TABLES

mogogo



H30" ROUND TABLE C-CVR-01-WBXX \ C-CVR-01-GBXX

INDEX



A PROFESSIONAL
FOOD & BEVERAGE
FURNITURE COMPANY

BORN A PASSION FOR Style & Gastronomy



Mogogo is led by designers and chefs that are aiming to introduce innovative, luxurious, and highly functional equipment to foodservice professionals.

A PERFECT BALANCE
OF LUXURY AND FUNCTION



LINENLESS



MODULAR



MOBILE



SUSTAINABLE



ADD ONS



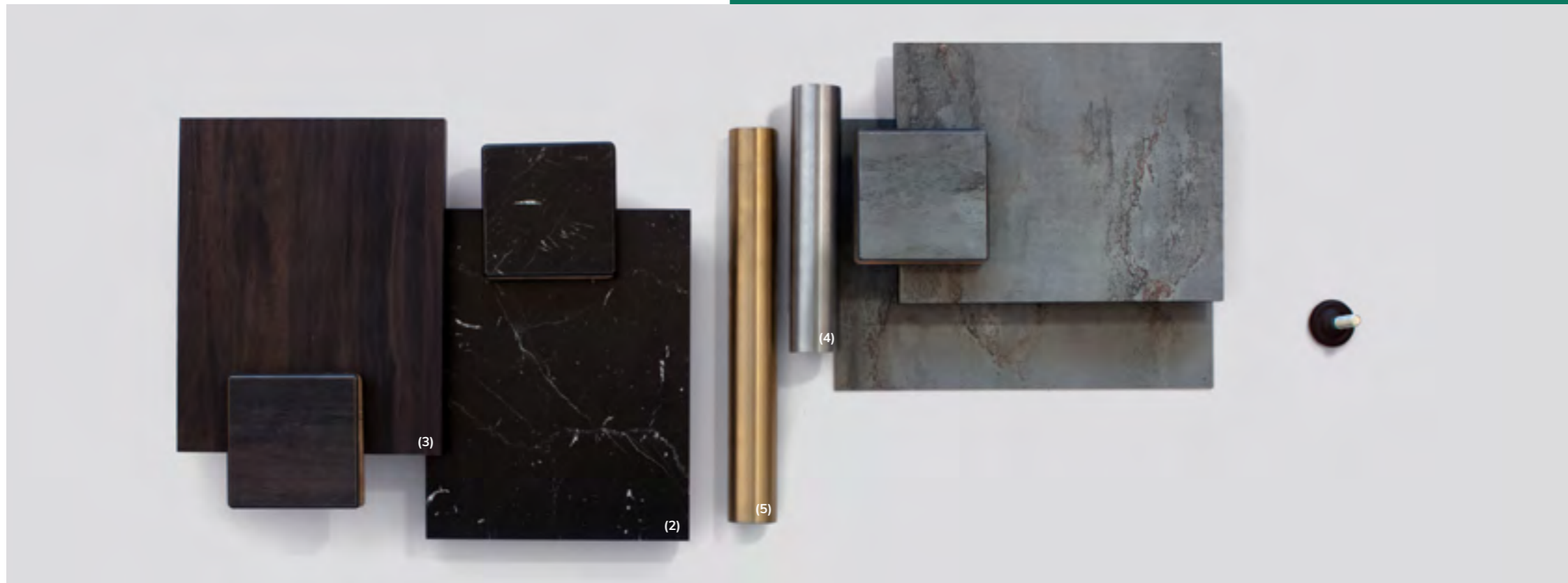

ABOUT CLI X COLLECTION

Like everything designed by Mogogo, CliX is both functional and beautiful, all while making the lives of our customers a little bit easier. CliX is inspired by the existing strengths of Mogogo's modular buffet furniture while further exploring versatility and adaptability. From these two function-defining parameters came our patent-pending quick-lock mechanism. One click to attach and one twist to detach, CliX delivers a product that is easy to assemble and store.

Available in three different heights as well as three tabletop shapes each with three different finishes, CliX is another part of our quest to produce tools for professionals that combine maximum functionality with a refined design aesthetic.

CliX Tables redefine aesthetic and functional standards in the realm of F&B catering.

MATERIALS

CliX tops are made of our innovative BHP material. BHP is a newly composed material that arrived after two years of intense R&D. It merges layers of High-Pressure Laminate with a Vertical Bamboo core (Mogogo's expertise) creating a lighter yet durable panel that offers new textures and colors. This new material combines the advantages of both bamboo and HPL, perfect for the ever-changing needs of the hospitality industry. Available in a variety of finishes that resemble natural materials such as Grey Slate, Nero Marquina Marble, and Bengali Mango Wood (1-3), CliX makes it easy to match with any event and decor.

The innovative bamboo core of the BHP goes in line with Mogogo's sustainability motto while the HPL's outer coating is durable for different environments, hygienic, and easy to clean.

CliX bases come in 2 modern chic finishes- brushed stainless steel (4) and brushed brass (5).

HOW IT WORKS

Our unique patent-pending quick-lock mechanism and universal base, for the CliX Tables collection, makes it easy to store, assemble, and disassemble: one click to attach and one twist to detach. With a multiplicity of tabletop/base combinations to choose from, CliX Tables provide you with an unprecedented array of display options. CliX Collection offers a variability of tabletop shapes and materials, as well as different base heights and finishes giving you the freedom to create an interesting visual landscape.

CliX Tables are an elegant design solution for any F&B operation. When you combine form and function, it just CliX.

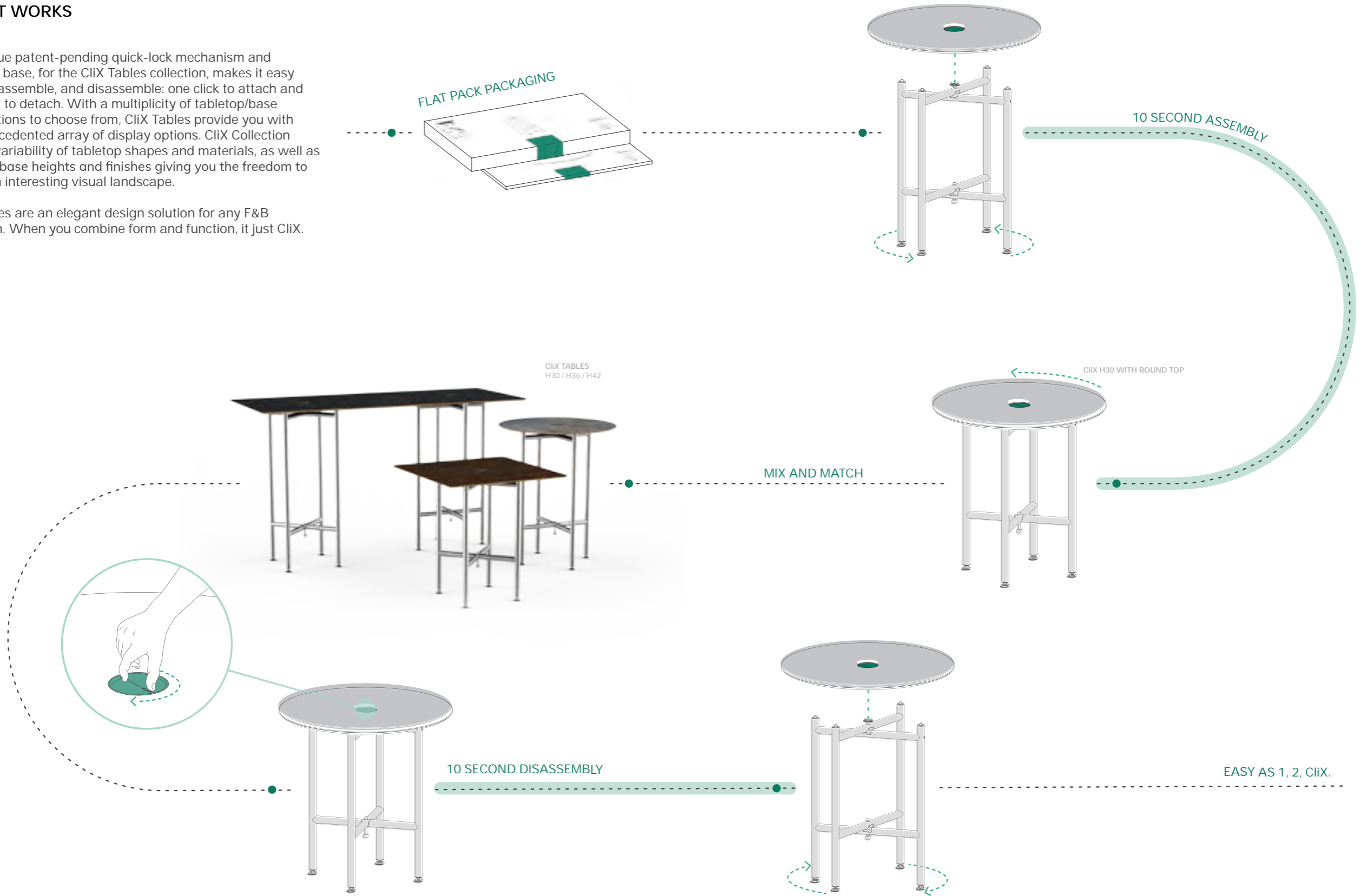



C-CVS-01-MSXX (shown with optional bottom shelf)



C-CYG-01-GSXX



COLOR COMBINATIONS

CliX's versatility allows for multiple color combinations, perfect for creating different vibes that are easily adaptable in multiple environments.



C-CZG-01-MBXX (shown with optional bottom shelves)

*
Mix Nero Marquina Marble finish with brass for an elegant, classy look, while Grey Slate with stainless gives it a more modern and sleek feel.



C-CVR-01-GBXX (shown with optional bottom shelf)

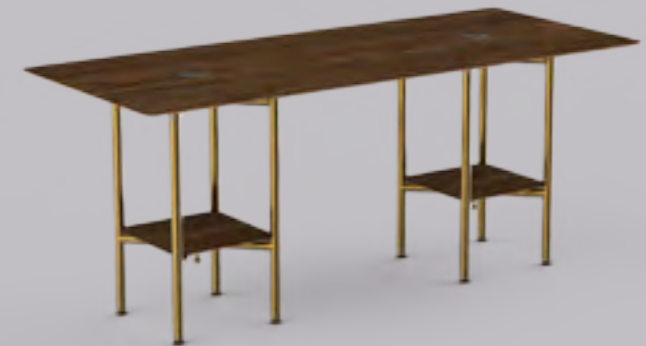

C-CVG-01-WBXX (shown with optional bottom shelves)



H30" RECTANGLE TABLE C-CVG-01-WBXX \ \ **H42" SQUARE TABLE** C-CZS-01-WBXX
(shown with optional Square BHP bottom shelves in a Bengali Mango Wood finish)



H30" SQUARE TABLE C-CVS-01-MSXX

H30" TABLES

CliX H30 embodies the most popular height for Catering Tables.

Standard in height, but not in design: CLiX H30 instantly elevates the event atmosphere to something quite sophisticated and chic.

Available in round, square, and rectangle tabletops, CliX H30 is an essential piece for any high end or laid back catering events; adding the perfect twist that clicks.

MATERIAL GUIDE

Customize your CliX Tables by choosing from the different colors and finishes available. Simply choose your preferred design combination by inserting the corresponding letter to its designated space as demonstrated below.

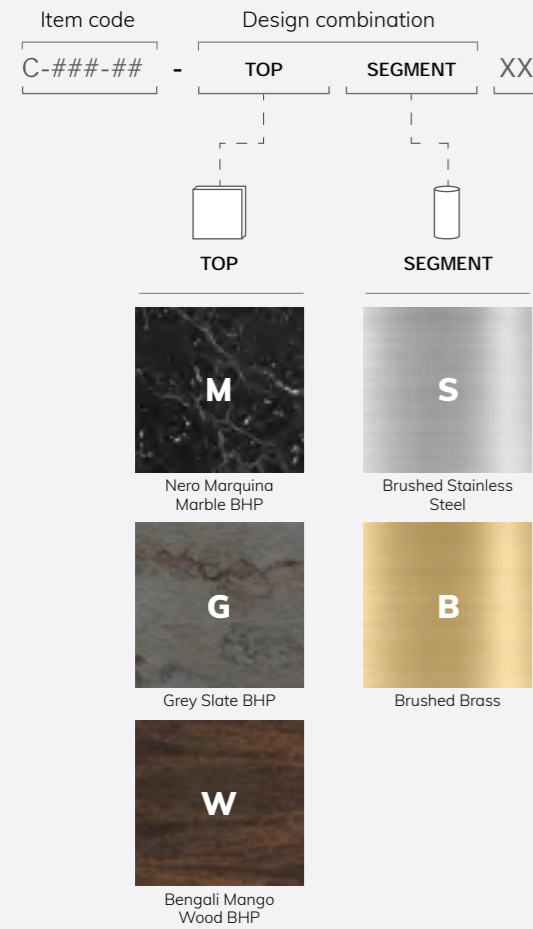

EXAMPLE:

C-CVR-01- W B XX =



H30" ROUND TABLE

CliX H30" | 76cm Base with a Round BHP top. Food displays will be at a whole other level with the CliX catering tables.

C-CVR-01- G B XX



H30" SQUARE TABLE

CliX H30" | 76cm Base with a Square BHP top. With these CliX tables, put together an events' buffet in just seconds.

C-CVS-01- M S XX



H30" RECTANGLE TABLE

CliX H30" | 76cm Base with a Rectangle BHP top. Showcase delicious food on a larger and elegant CliX Table.

C-CVG-01- W S XX



H36" SQUARE TABLE C-CYS-01-MSXX

(shown with optional Square BHP bottom shelf in a Nero Marquina Marble finish)

H30" ROUND TABLE C-CVR-01-GSXX

(shown with optional Round BHP bottom shelf in a Grey Slate finish)



H36" RECTANGLE TABLE C-CYG-01-WBXX

H36" TABLES

CliX H36 serves as the perfect intermediate between a Bar and Dining Table height.

Created to add further vertical diversity, it is a great addition to its other catering companions.

Available in round, square, and rectangle tabletops, CliX H36 completes the vision of a diverse and surprising visual landscape for any event.

MATERIAL GUIDE

Customize your CliX Tables by choosing from the different colors and finishes available.
Simply choose your preferred design combination by inserting the corresponding letter to its designated space as demonstrated below.

Item code: C-###-##
Design combination: TOP SEGMENT XX

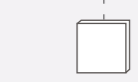

TOP



SEGMENT

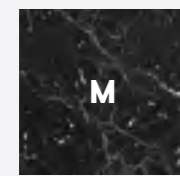

M
Nero Marquina
Marble BHP



S
Brushed Stainless
Steel

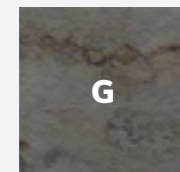

G
Grey Slate BHP

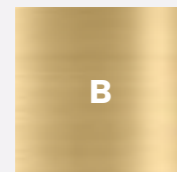

B
Brushed Brass

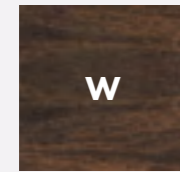

W
Bengali Mango
Wood BHP

EXAMPLE:

C-CVR-01- W B XX

=



H36" ROUND TABLE

CliX H36" | 91cm Base with a Round BHP top.
Smoothly gather guests around CliX tables at any event.

C-CYR-01- M S XX



H36" SQUARE TABLE

CliX H36" | 91cm Base with a Square BHP top.
Easily mobile and light, the CliX are perfect for ever-changing events.

C-CYS-01- W B XX



H36" RECTANGLE TABLE

CliX H36" | 91cm Base with a Rectangle BHP top.
This CliX rectangular shape allows for multiple food displays and options.

C-CYG-01- G S XX



H42" SQUARE TABLE C-CZS-01-WBXX
 (shown with optional Square BHP bottom shelf in a Bengali Mango Wood finish)



H42" RECTANGLE TABLE C-CZG-01-GSXX || **H36" ROUND TABLE** C-CYR-01-GSXX
 (shown with optional Round BHP bottom shelf in a Grey Slate finish)

H42" TABLES

CliX H42 is a high and lightweight catering table, perfect as a High-Boy Bar Table or simply used as a Display table.

Ten seconds to assemble, ten seconds to disassemble, discover a new dimension of functionality with our patent pending mechanism.

Available in round, square, and rectangle tabletops, CliX H42 will upgrade any catering space into a high-end-design social environment.

MATERIAL GUIDE

Customize your CliX Tables by choosing from the different colors and finishes available. Simply choose your preferred design combination by inserting the corresponding letter to its designated space as demonstrated below.

Item code: C-###-##
 Design combination: TOP SEGMENT XX

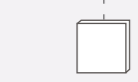

TOP



SEGMENT



M
Nero Marquina
Marble BHP



S
Brushed Stainless
Steel

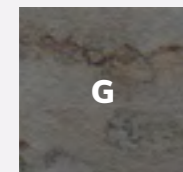

G
Grey Slate BHP

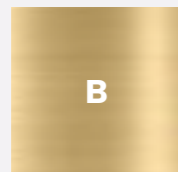

B
Brushed Brass

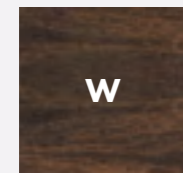

W
Bengali Mango
Wood BHP

EXAMPLE:

C-CVR-01- W B XX

=



H42" ROUND TABLE

CliX H42" | 106cm Base with a Round BHP top.
Scatter these CliX tables around the venue to present different finger foods and cocktails.

C-CZR-01- G S XX



H42" SQUARE TABLE

CliX H42" | 106cm Base with a Square BHP top.
Quickly set the atmosphere of any event with these stunning tables.

C-CZS-01- W S XX



H42" RECTANGLE TABLE

CliX H42" | 106cm Base with a Rectangle BHP top.
The ideal CliX table for larger buffet spreads and food displays.

C-CZG-01- M B XX

DAY & NIGHT

ClIX tables can help serve guests by the poolside in the morning, as well as gathering them around elegant bar tables in ballroom evening events.



H30" RECTANGLE TABLE C-CVG-01-WSXX



H42" ROUND TABLE C-CZR-01-MBXX
(shown with optional Round BHP bottom shelf in a Nero Marquina Marble finish)



H42" SQUARE TABLE C-CZS-01-MBXX
(shown with optional Square BHP bottom shelf in a Nero Marquina Marble finish)



TRANSFER & STORAGE CARTS

Mogogo's utility carts are designed for your convenience and mobility and are an integral part of the CliX system as they make storing and assembling the tables easy. Whether it is to pull out the tabletops, to push them through the halls, or get in and out of elevators, they make the behind the scenes of your time-sensitive events easier and give you an extra push on productivity.

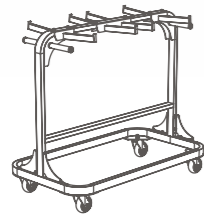

LEG TRANSFER AND STORAGE CART
L55.5" W31" H50"
L141cm W79cm H127.5cm
holds up to 16 folded CliX legs

C-UUX-02-XXXX

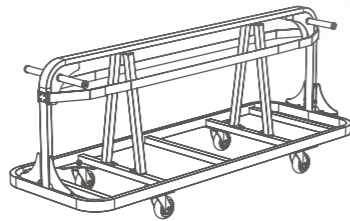

LARGE PLATE TRANSFER AND STORAGE CART
L86.5" W31" H36.5"
L220cm W79cm H92.5cm
holds up to 18 CliX rectangle tops

C-UUX-03-XXXX

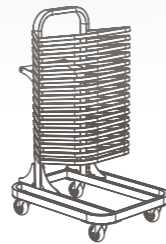

ROUND / SQUARE TOP TRANSFER AND STORAGE CART
L40" W31" H61"
L101cm W79cm H155cm
holds up to 16 CliX round/square tops

C-UUX-04-XXXX



ROUND / SQUARE TOP TRANSFER AND STORAGE CART C-UUX-04-XXXX



SYSTEM BREAKDOWN

Mogogo's CliX Catering Tables Collection offers endless combinations with only two basic elements at its core: Tabletop and Base.

Tabletops are available in three shapes and Three different materials. Table Bases are available in three heights and two stunning finishes. Bottom shelves are available in two shapes to add extra storage or display space.

Delivering on our promise of high functionality and diversity, the CliX Collection reveals a new paramount in product design for hospitality.

BASES

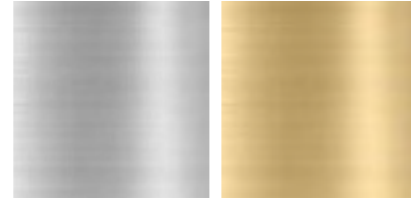

Brushed Stainless Steel

Brushed Brass

S-CLX-SS-01

S-CLX-BR-01

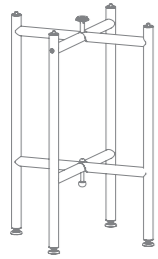

30" BASE
H30" | H76cm

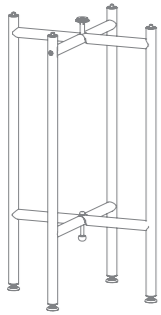

36" BASE
H36" | H91cm

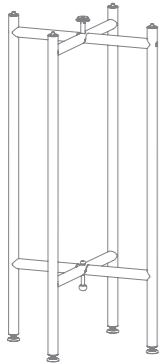

42" BASE
H42" | H106cm

S-CLX-SS-03

S-CLX-BR-03

TOPS



Bengali Mango
Wood BHP

Grey Slate BHP

Nero Marquina
Marble BHP



S-CXT-HW-01

S-CXT-HG-01

S-CXT-HB-01

RECTANGLE BHP TOP
L72" W30" | L182cm W76cm



S-CXT-HW-02

S-CXT-HG-02

S-CXT-HB-02

ROUND BHP TOP
Ø30" | Ø76cm



S-CXT-HW-03

S-CXT-HG-03

S-CXT-HB-03

SQUARE BHP TOP
30" | 76cm

SHELVES



S-CXB-HW-01

S-CXB-HG-01

S-CXB-HB-01

ROUND BHP BOTTOM SHELF
Ø18.5" | Ø47cm

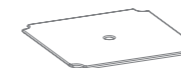

S-CXB-HW-02

S-CXB-HG-02

S-CXB-HB-02

SQUARE BHP BOTTOM SHELF
14" | 36cm

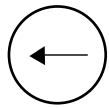

Back to
Catalog
Selection



Canvas
SHELVING SYSTEM

mogogo

2023\2024



BASE UNIT WITH CASTERS | HANGER BAR | ANGELD SHELF | CRATE
BOTTLE HOLDER | SHELF | SHELF RETAINING BAR | SHELF WITH BORDER | DIVIDER

INDEX

- 4 [About Mogogo](#)
- 8 [About the Canvas Collection](#)
- 9 [Materials](#)
- 10 [How It Works](#)
- 12 [Details](#)
- 14 [Single unit - basic shelves](#)
- 18 [Single unit - mixed add-ons](#)
- 22 [Single unit - crates and more](#)
- 28 [Multi unit configurations](#)
- 34 [System breakdown](#)
- 36 [Add-ons](#)
- 40 [Express your shelf](#)



A MODULAR F&B
FURNITURE BRAND

BORN FROM A PASSION FOR **STYLE & GASTRONOMY**



Mogogo is led by designers and chefs that are aiming to introduce innovative, luxurious, and highly functional equipment to foodservice professionals.



LINENLESS



MODULAR



MOBILE



SUSTAINABLE



ADD ONS



THE BAR IS OPEN

BACK BAR UNIT SEE PAGE 30

MIXOLOGY SERVICE CART C-RNX-03-BSXX

ROUND POLO DISPLAY TABLE C-PPR-01-MBXX

PRO BAR STATION C-MLC-05-GSXW



ABOUT THE CANVAS COLLECTION

The Canvas Collection is an innovative shelving system for the hospitality sector, acting as a blank page allowing professionals to accomplish their creative vision. The collection is ideal as a back bar or for showcasing food and beverages and related products.

It combines function with uncluttered aesthetics to create this versatile range of shelving, taking into consideration the unique and challenging requirements of foodservice.



MATERIALS

The usage of ecological materials is part of a global movement that aims to convey the message that luxury and sustainability go together. The bamboo frame is lightweight and highly structural, joined by decorative metal features to create a fine balance between traditional woodcraft and modern design.

Natural horizontal bamboo | Sandblasted Stainless Steel. NATURAL

Dark brown stained bamboo | Sandblasted Copper-plated Stainless Steel. DARK LUX

HOW IT WORKS

Starting with an unfilled Canvas structure then adding selected fixtures, allows creating stations with specific needs, and the ability to seamlessly connect several units offers the flexibility to construct configurations fitting any size or shape of space.

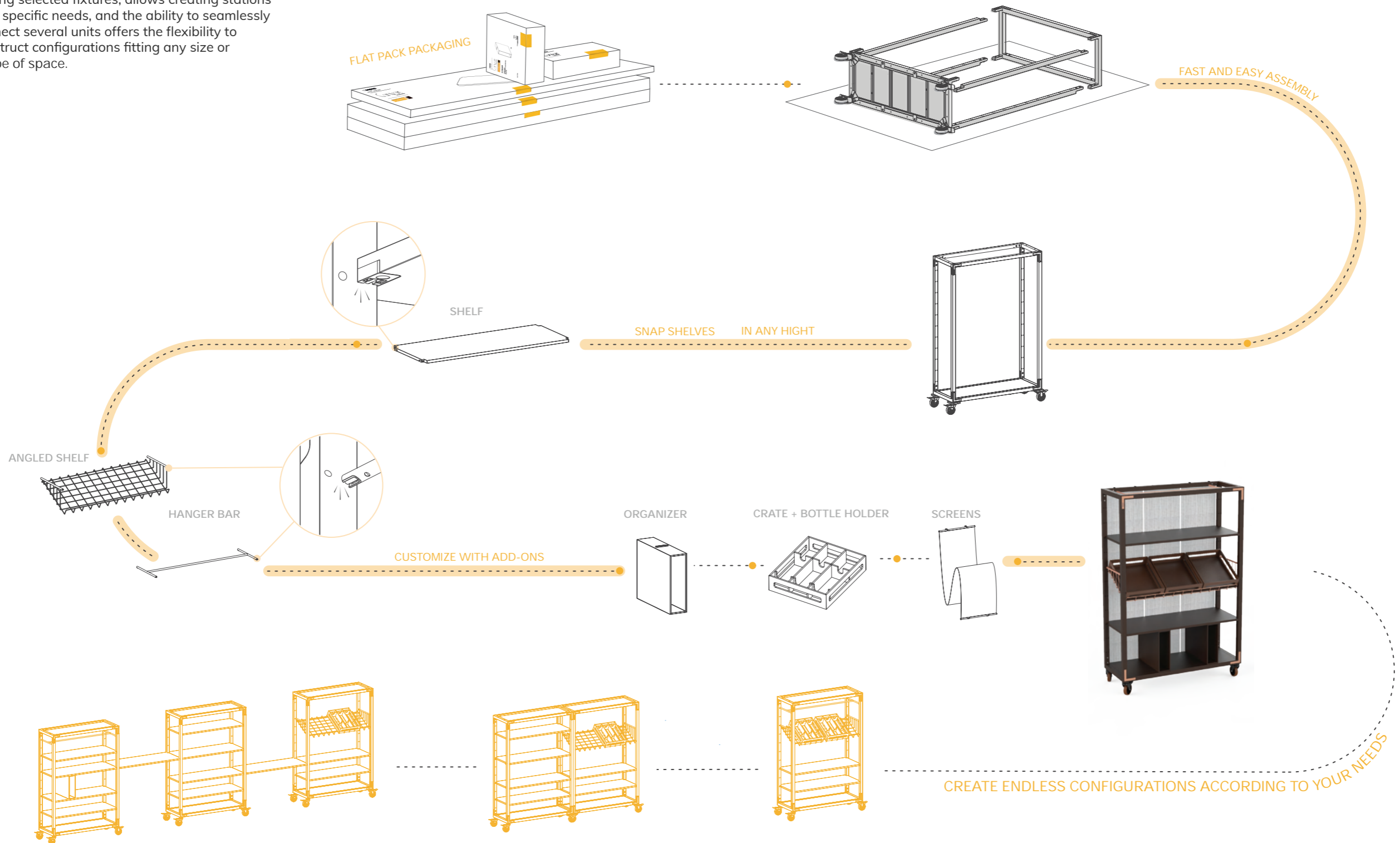

DETAILS

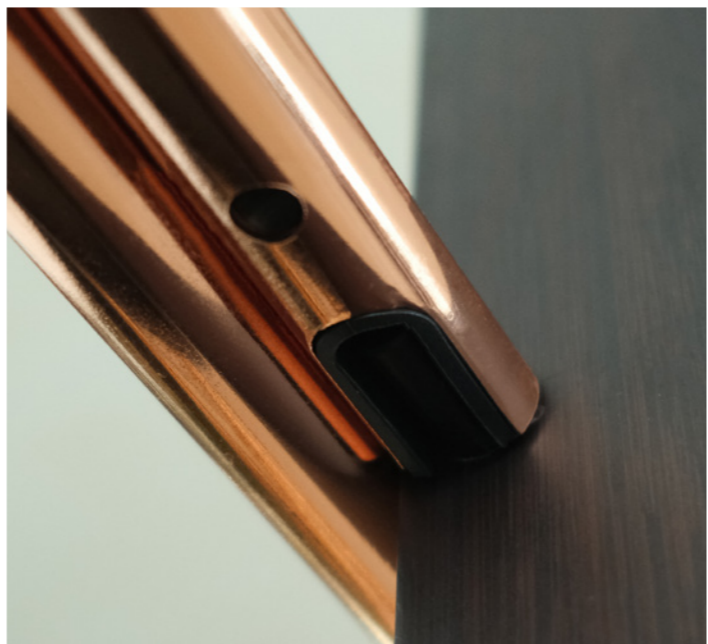



BUSSING STATION C-CAN-14-NSXW



SINGLE UNIT - BASIC SHELVES

Organization and accessibility are foundation stones for a functional station. Whether it is used front of house or behind the scenes, several shelves can be set at different heights in a matter of seconds creating a practical and stylish tool.

The unit can be covered partially or completely with the use of easy to install screens.

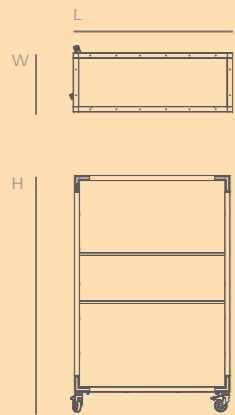

L48½" W18" H73½"
L122.5cm W46cm H186cm



TWO SHELF UNIT

- NATURAL | CASTERS C-CAN-17-NSXW
- NATURAL | LEGS C-CAN-17-NSXF
- DARK-LUX | CASTERS C-CAN-17-DCXW
- DARK-LUX | LEGS C-CAN-17-DCXF

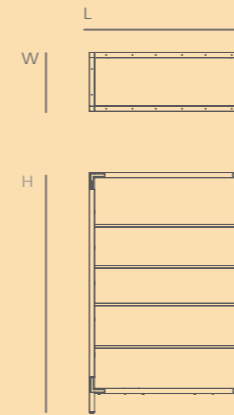

L48½" W18" H73½"
L122.5cm W46cm H186cm



FOUR SHELF UNIT

- NATURAL | CASTERS C-CAN-18-NSXW
- NATURAL | LEGS C-CAN-18-NSXF
- DARK-LUX | CASTERS C-CAN-18-DCXW
- DARK-LUX | LEGS C-CAN-18-DCXF

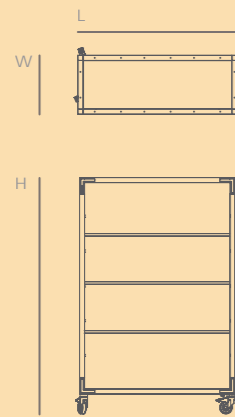

L48½" W18" H73½"
L122.5cm W46cm H186cm



THREE SHELF UNIT

- NATURAL | CASTERS C-CAN-14-NSXW
- NATURAL | LEGS C-CAN-14-NSXF
- DARK-LUX | CASTERS C-CAN-14-DCXW
- DARK-LUX | LEGS C-CAN-14-DCXF

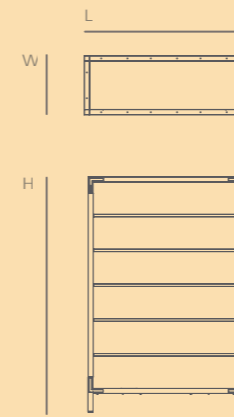

L48½" W18" H73½"
L122.5cm W46cm H186cm



FIVE SHELF UNIT

- NATURAL | CASTERS C-CAN-09-NSXW
- NATURAL | LEGS C-CAN-09-NSXF
- DARK-LUX | CASTERS C-CAN-09-DCXW
- DARK-LUX | LEGS C-CAN-09-DCXF

SINGLE UNIT - MIXED ADD-ONS

Mixing and matching is as simple as ever, and while installing the add-ons is user-friendly, the outcome is sophisticated and versatile. The shelf selection and designated add-ons are intended to offer you the freedom of expression when presenting food and beverage or your decoration of choice.



ROOM DIVIDER C-CAN-08-DCXW

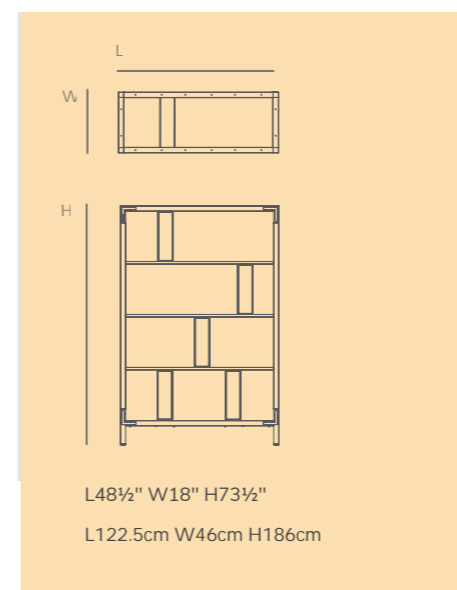

ROOM DIVIDER

This Room Divider creates a sophisticated atmosphere and lining up multiple units can create division and a seamless appearance to any space. The shelf rail allows the dividers to be moved easily while in place to achieve a customized solution for your specific needs.



NATURAL | CASTERS.....C-CAN-08-NSXW
 ■ NATURAL | LEGS.....C-CAN-08-NSXF
 DARK-LUX | CASTERS.....C-CAN-08-DCXW
 DARK-LUX | LEGS.....C-CAN-08-DCXF

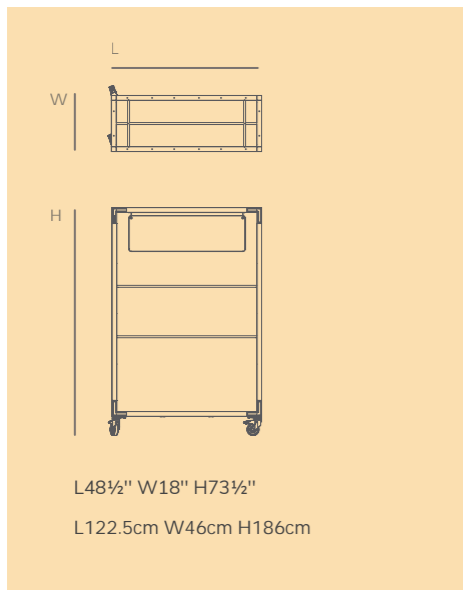

L48½" W18" H73½"
L122.5cm W46cm H186cm



DESSERT STATION

This unit aims to focus attention on selected food items, such as exquisite "petit fours" or other food creations you wish to treat and showcase as jewels. It comes with two shelves and a slick sign to let your guests know what all the fuss is about.

- NATURAL | CASTERS.....C-CAN-15-NSXW
- NATURAL | LEGS.....C-CAN-15-NSXF
- DARK-LUX | CASTERS.....C-CAN-15-DCXW
- DARK-LUX | LEGS.....C-CAN-15-DCXF

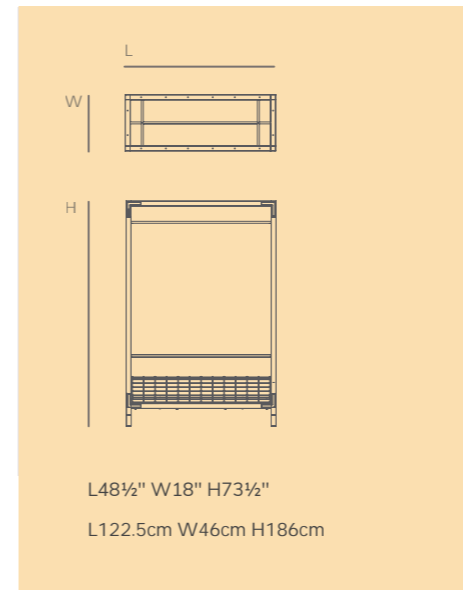

L48½" W18" H73½"
L122.5cm W46cm H186cm



COAT RACK

The Canvas system function can be stretched beyond the common usage to other hospitality areas, such as this portable coat rack station and many others, helping to overcome your daily challenges.

- NATURAL | CASTERS.....C-CAN-11-NSXW
- NATURAL | LEGS.....C-CAN-11-NSXF
- DARK-LUX | CASTERS.....C-CAN-11-DCXW
- DARK-LUX | LEGS.....C-CAN-11-DCXF

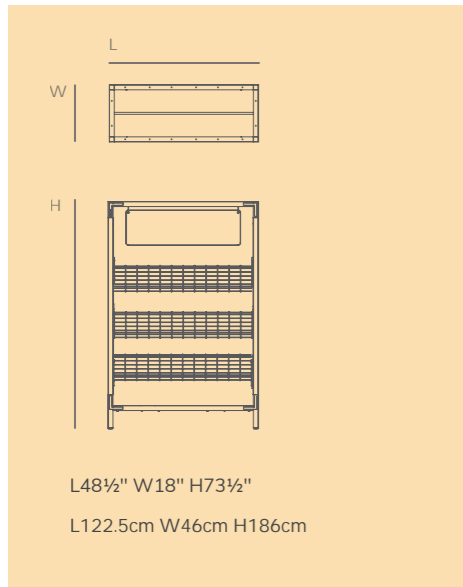

L48½" W18" H73½"
L122.5cm W46cm H186cm



ANGLED SHELF SIGNAGE UNIT

This unit takes food presentation seriously! The angled stainless steel wire shelf offers food and related ingredients to be presented in an optimal style, and the hanging blackboard sign allows you to compose a unique story time after time.

- NATURAL | CASTERS.....C-CAN-16-NSXW
- NATURAL | LEGS.....C-CAN-16-NSXF
- DARK-LUX | CASTERS.....C-CAN-16-DCXW
- DARK-LUX | LEGS.....C-CAN-16-DCXF

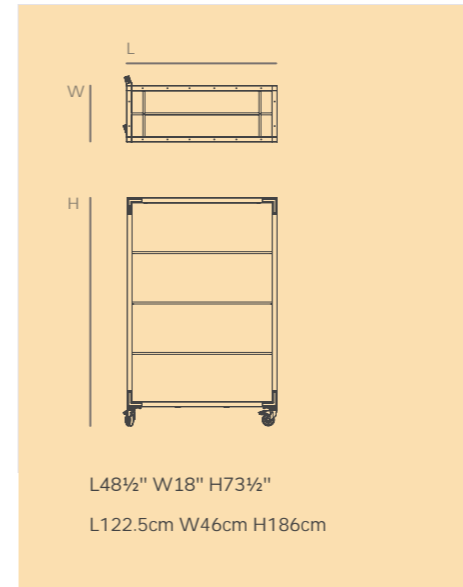

L48½" W18" H73½"
L122.5cm W46cm H186cm



HANGING UNIT

A clean and mentalistic hanging station offers to use the Canvas in exacting ways and discover new ideas to wow your guests, such as an indoor vertical herb garden or other ideas that you will come up with.

- NATURAL | CASTERS.....C-CAN-10-NSXW
- NATURAL | LEGS.....C-CAN-10-NSXF
- DARK-LUX | CASTERS.....C-CAN-10-DCXW
- DARK-LUX | LEGS.....C-CAN-10-DCXF



GRAB AND GO SIGNAGE UNIT C-CAN-03-NSXW



SINGLE UNIT - CRATES AND MORE

This group of configurations is defined by the crates they hold, allowing the operator to store and display most anything they wish. Combined with shelving and signage, they can perform many functions in a variety of locations while offering versatility and beauty.

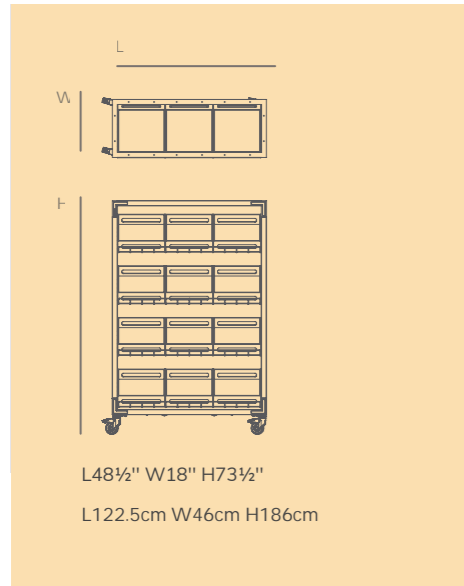

ANGLED SHELF UNIT

The wooden display crates with fresh vegetables, breads, combined with the olive oil bottles, bags of flour and other quality ingredients, are sure to tell your guest that a wonderful dish is on the way. Ultimately, completing the sensory experience that is so essential in hospitality!

- NATURAL | CASTERS C-CAN-12-NSXW
- NATURAL | LEGS C-CAN-12-NSXF
- DARK-LUX | CASTERS C-CAN-12-DCXW
- DARK-LUX | LEGS C-CAN-12-DCXF

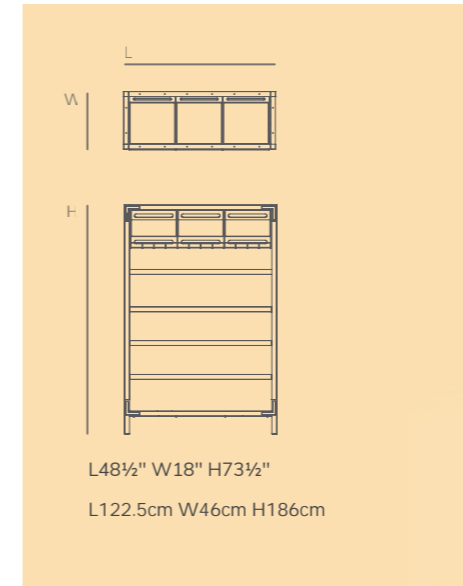

GRAB AND GO UNIT

Snacks, fruit and a variety of goods your guests desire to Grab and Go, will be displayed perfectly on this Canvas configuration. The angled shelf will improve visibility and create a complete experience.

- NATURAL | CASTERS C-CAN-02-NSXW
- NATURAL | LEGS C-CAN-02-NSXF
- DARK-LUX | CASTERS C-CAN-02-DCXW
- DARK-LUX | LEGS C-CAN-02-DCXF

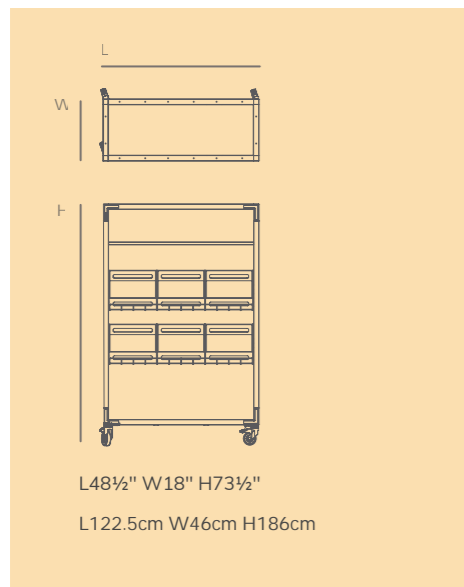

FARM TO TABLE

What is more appetizing than knowing that what you are about to eat is made from farm fresh ingredients. This Farm to Table Station was developed with this in mind and provides you a variety of display solutions that can effortlessly be customized according to the menu.

- NATURAL | CASTERS C-CAN-04-NSXW
- NATURAL | LEGS C-CAN-04-NSXF
- DARK-LUX | CASTERS C-CAN-04-DCXW
- DARK-LUX | LEGS C-CAN-04-DCXF

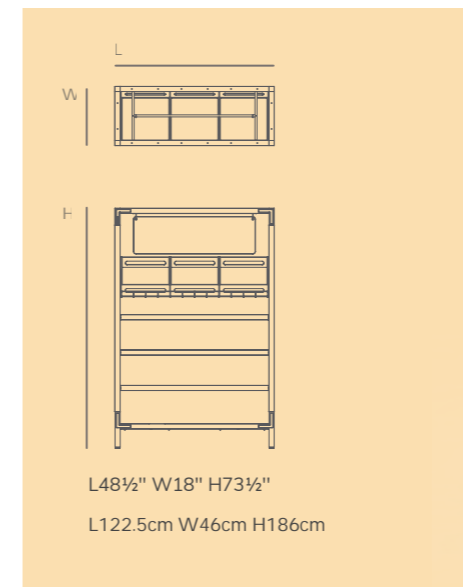

GRAB AND GO SIGNAGE UNIT

Like the Grab and Go unit above, it has the angled shelf, but also includes a chalkboard to make it very clear to your guests that tasty treats are available.

- NATURAL | CASTERS C-CAN-03-NSXW
- NATURAL | LEGS C-CAN-03-NSXF
- DARK-LUX | CASTERS C-CAN-03-DCXW
- DARK-LUX | LEGS C-CAN-03-DCXF



FARM TO TABLE C-CAN-04-DCXW
THREE SHELF UNIT C-CAN-14-NSXW
GRAB AND GO SIGNAGE UNIT C-CAN-03-NSXW



CENTER STAGE DISPLAY C-CAN-19-NSXW
 (Shown with optional Golden-Brown screens)

MULTI UNIT CONFIGURATIONS

If your space allows the use of several units, the addition of the unit connectors, straight shelves and corner shelves, is a cost effective way to add additional display space. In addition, it creates straight or angled structures that act as living walls, allowing you to express your artistic talents.

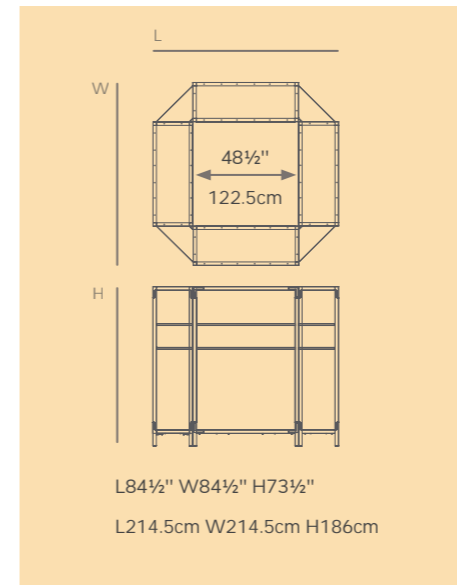

CENTER STAGE DISPLAY

Whether you're trying to make a statement in the middle of your room or wanting to utilize the space around that awkward pillar, this station will do both. The ability to connect the Canvas shelving units with the corner shelf connectors adds a dimension the traditional buffet furniture lacks and the results can be functional and stunning.

- NATURAL | CASTERS C-CAN-19-NSXW
- NATURAL | LEGS C-CAN-19-NSXF
- DARK-LUX | CASTERS C-CAN-19-DCXW
- DARK-LUX | LEGS C-CAN-19-DCXF



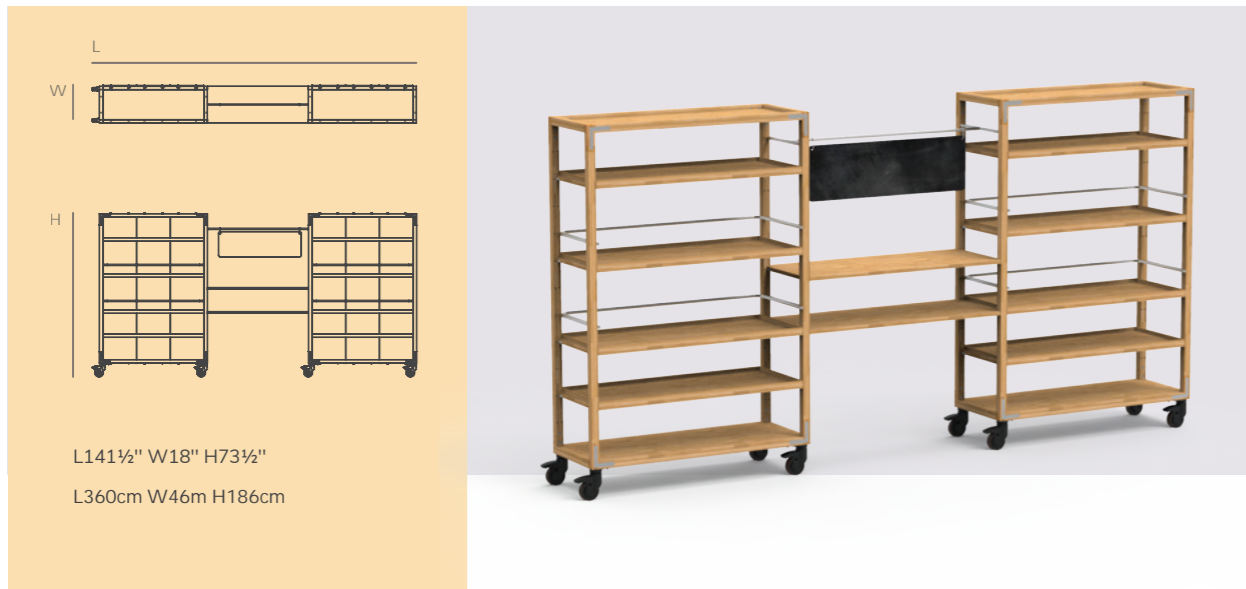

L141½" W18" H73½"
L360cm W46m H186cm

BACK BAR UNIT

A luxurious back bar tells a story and lets your guest know that they have arrived at their destination and will be treated accordingly. Whether they seek a revitalizing cocktail or a glass of wine, the look and feel you create will set the tone.

- NATURAL | CASTERS.....C-CAN-05-NSXW
- NATURAL | LEGS.....C-CAN-05-NSXF
- DARK-LUX | CASTERS.....C-CAN-05-DCXW
- DARK-LUX | LEGS.....C-CAN-05-DCXF



L141½" W18" H73½"
L360cm W46cm H186cm

COFFEE LOUNGE

Double espresso, butter Croissant, and the newspaper of the day! No matter where you wake up, it's a great way to start another busy day. The flexibility of the Canvas Collection can turn your pleasant but hard to utilize space into an attractive area that gives a look and feel of a neighborhood café.

- NATURAL | CASTERS.....C-CAN-07-NSXW
- NATURAL | LEGS.....C-CAN-07-NSXF
- DARK-LUX | CASTERS.....C-CAN-07-DCXW
- DARK-LUX | LEGS.....C-CAN-07-DCXF



L145" W18" H73½"
L367.5cm W46cm H186cm

WINE DISPLAY

At the end of the day, a glass of red wine, cheese, and snacks can turn into a worthy memory. This elegant configuration allows for the serving of wine and related foods in a way that is sure to impress. Each unit comes with casters allowing for easy mobility when moving from one event to another.

- NATURAL | CASTERS.....C-CAN-06-NSXW
- NATURAL | LEGS.....C-CAN-06-NSXF
- DARK-LUX | CASTERS.....C-CAN-06-DCXW
- DARK-LUX | LEGS.....C-CAN-06-DCXF



L141½" W18" H73½"
L360cm W46cm H186cm

SELF SERVICE

Juice boxes or sweets? What decorations will enhance the experience to create something modern and minimalist, or a warmer and more country style. The self service configuration gives you the tools to express your desired concept no matter what the occasion is.

- NATURAL | CASTERS.....C-CAN-01-NSXW
- NATURAL | LEGS.....C-CAN-01-NSXF
- DARK-LUX | CASTERS.....C-CAN-01-DCXW
- DARK-LUX | LEGS.....C-CAN-01-DCXF

IS/CDG				
ENHAGEN				
LIN				
AI				
LX	1487	1	161 - 243	CHECK-IN
ULC	8655	2	245 - 247	CHECK-IN
OS	0708	2	204 - 205	CHECK-IN
CZ	7122	2		KIOSK
DY	3581	2		KIOSK
EI	0645	1		
EK	0140	1	171 - 178	CHECK-IN



COFFEE LOUNGE C-CAN-07-DCXW
(shown with optional Charcoal-Black Screens)



C-CAN-04-DCXW

SYSTEM BREAKDOWN

Starting with a blank rectangular structure (on casters or legs) acting as an empty page that awaits your ideas and needs to be explored. Our Canvas Shelving System was born from the basic idea that your F&B Furniture should adapt to your ever-varying needs during different functions. It allows you to pick and choose basic elements such as shelves with or without borders, hanging bars, signs, organizers, and more.

BUILD YOUR OWN UNITS

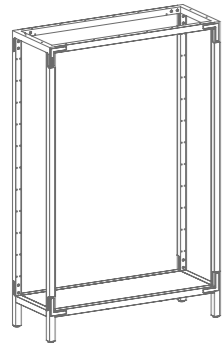

EMPTY UNIT WITH LEGS
L48½" W18" H73½"
L122.5cm W46cm H186cm



Natural horizontal bamboo sandblasted stainless steel

C-CAN-13-NSXF



Dark brown stained bamboo Sandblasted Copper plating

C-CAN-13-DCXF

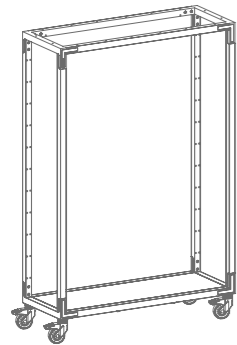

EMPTY UNIT WITH CASTERS
L48½" W18" H73½"
L122.5cm W46cm H186cm

C-CAN-13-NSXW

C-CAN-13-DCXW

ADD-ONS SHELVES



Natural horizontal bamboo sandblasted stainless steel

S-CAN-BM-02



Dark brown stained bamboo Sandblasted Copper plating

S-CAN-DB-02

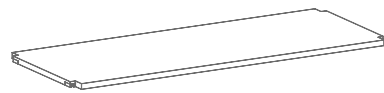

SHELF
L46½" W18" H0.8"
L118.5cm W46cm H2cm



SHELF WITH BORDER
L46½" W18" H1½"
L118.5cm W46cm H4cm

S-CAN-BM-07

S-CAN-DB-07

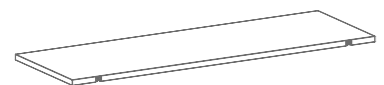

TOP FRAME SHELF
L45" W15" H0.8"
L114.5cm W38cm H2cm

S-CAN-BM-06

S-CAN-DB-06

ADD-ONS



Natural horizontal bamboo sandblasted stainless steel

S-CAN-SS-01



Dark brown stained bamboo Sandblasted Copper plating

S-CAN-SC-01



HANGER BAR
Comes with 5 Hooks
L46½" W15" H½"
L118cm W38cm H1.6cm



TOP FRAME HANGER BAR
Comes with 5 Hooks
L38" W16½" H½"
L96cm W41.5cm H1.5cm

S-CAN-SS-02

S-CAN-SC-02

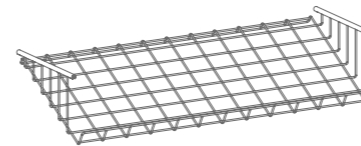

ANGLED SHELF
Can fit up to 3 crates
L46½" W18" H9½"
L118cm W46cm H24cm

S-CAN-SS-03

S-CAN-SC-03



SHELF RETAINING BAR
L46½" W18" H0.6"
L118cm W46cm H1.6cm

S-CAN-BM-07

S-CAN-SC-04

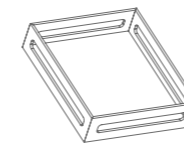

CRATE
L17½" W14½" H4"
L44cm W37.5cm H10cm

S-CAN-BM-03

S-CAN-DB-03

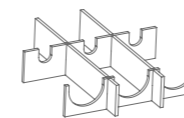

BOTTLE HOLDER
fits Crate
L16½" W14" H3½"
L42.5cm W36cm H8.5cm

S-CAN-BM-04

S-CAN-DB-04

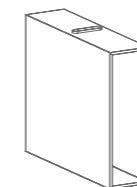





ORGANIZER
L18" W4½" H15½"
L46cm W12cm H39cm

S-CAN-BM-05

S-CAN-DB-05



ADD-ONS

			
		Natural horizontal bamboo sandblasted stainless steel	Dark brown stained bamboo Sandblasted Copper plating
	UNIT CONNECTORS To connect two units Set of 2 L15" W1.5" H0.8" L38cm W4cm H2cm	S-CAN-BM-09	S-CAN-DB-09
	CORNER SHELF CONNECTOR To connect two units in 90° Set of 2 L18" W18" H0.8" L46cm W46cm H2cm	S-CAN-BM-11	S-CAN-DB-11

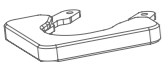
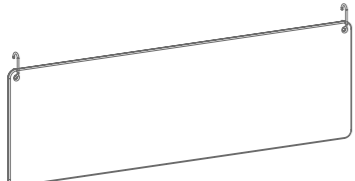
MISCELLANEOUS ADD-ONS

	BUMPERS set of 4 L5" W5" H0.6" L12cm W12cm H1.6cm	S-CAN-SM-08	S-CAN-SM-08
	SIGN Comes with 2 Hooks L37" W11½" H½" L94cm W29cm H1cm	S-CAN-SM-09	S-CAN-SM-09

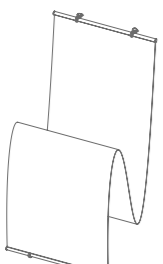
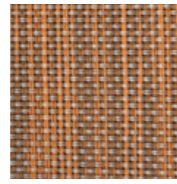
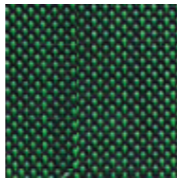
SCREENS

				
		Golden-Brown	Jungle-Green	Charcoal-Black
	EASY TO INSTALL SCREENS Set of 5- Available in various colors L67" W15" L170cm W38cm	S-CAN-PV-02	S-CAN-GP-01	S-CAN-PV-01



COAT RACK C-CAN-11-NSXW

Sketch your own Canvas configuration by choosing from a variety of shelves and add-ons using the 2D drawing to explore options.

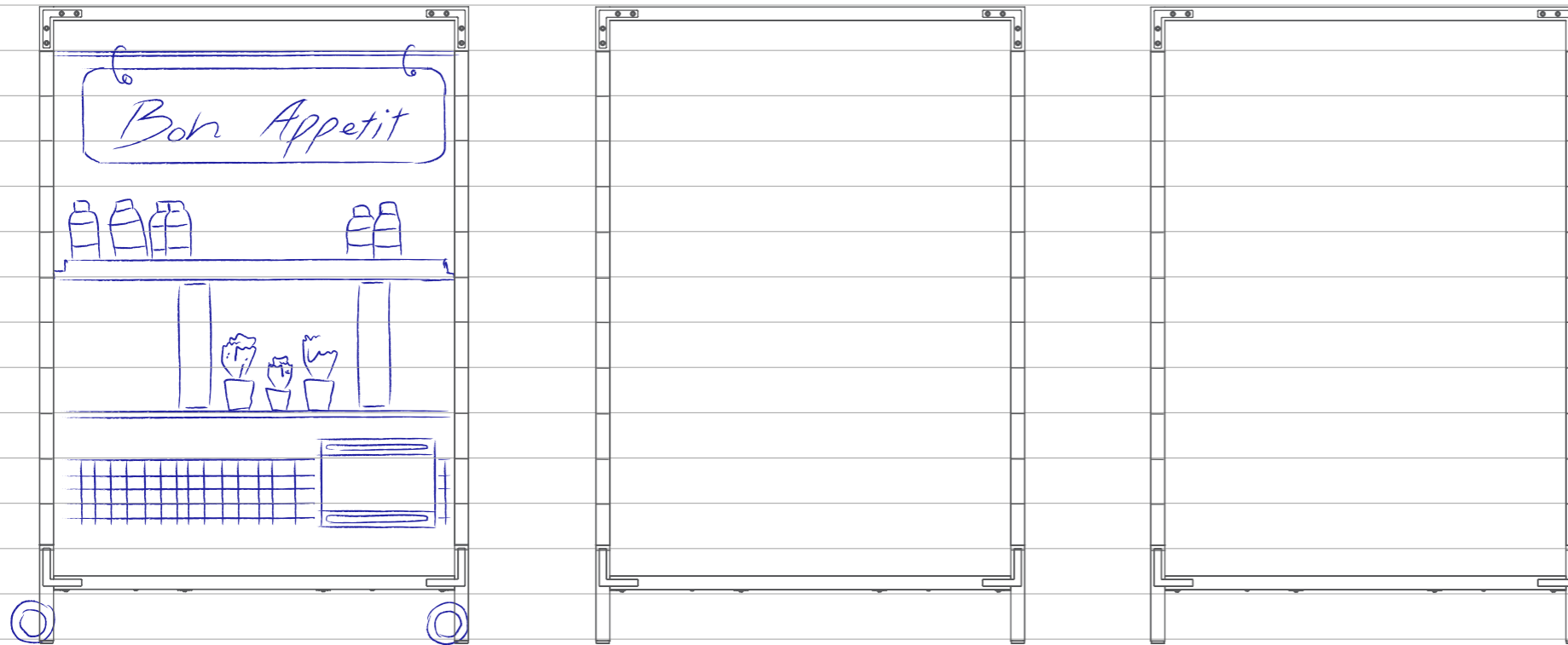

- TOP FRAME SHELF 
- SHELF 
- ANGLED SHELF 
- SHELF WITH BORDER 
- SHELF RETAINING BAR 
- SIGN 
- TOP FRAME HANGER BAR 
- HANGER BAR 
- CRATE 
- BOTTLE HOLDER 
- BUMPERS 
- ORGANIZER 

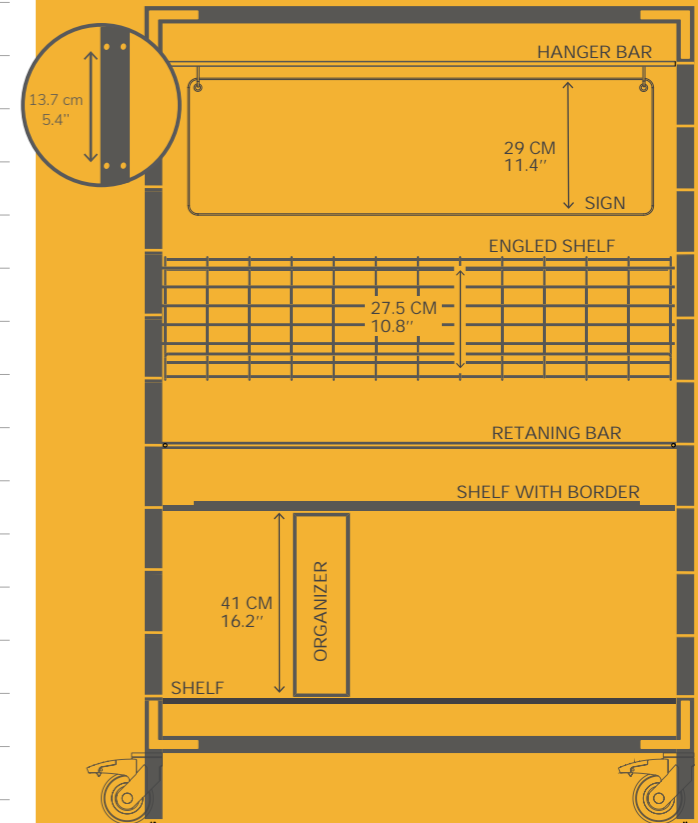
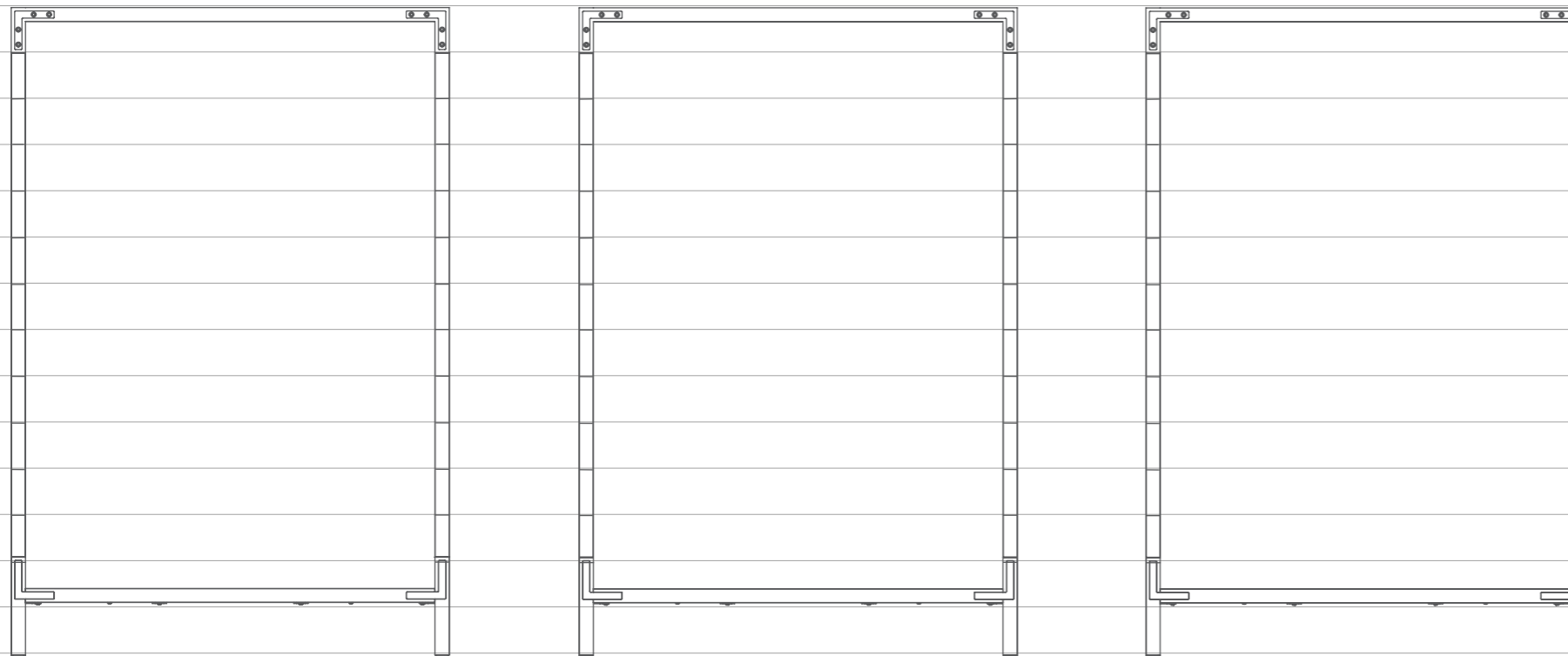

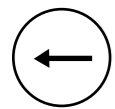

Back to
Catalog
Selection



Grobit

SIDE TABLES

mogogo



FEATURES AND MATERIALS.

The unique design includes a genuine leather handle for effortless carrying, and the thin metal base easily slides under chairs. The beautiful and durable BHP top come in a variety of finishes - (1) Nero Marquina Marble, (2) Grey Slate, (3) Bengali Mango Wood.

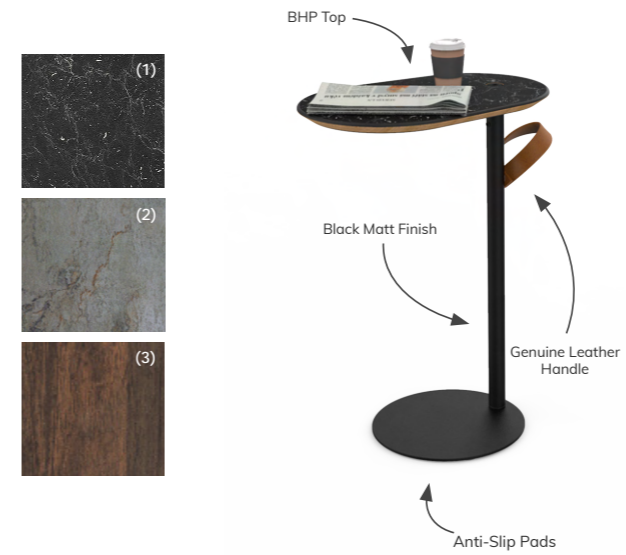

ABOUT GRABIT COLLECTION

The Grabit collection introduces portable side tables for hospitality. These tables fit the Grab & Go serving style, designed to carry around and suitable for a variety of uses in many settings and scenarios.

L45cm W33cm H65cm
L17.7" W13" H25.5"

- GRABIT TABLE | BENGALI MANGO WOOD.....C-GRB-01-WPXX
- GRABIT TABLE | NERO MARQUINA MARBLE TOP.....C-GRB-01-MPXX
- GRABIT TABLE | GREY SLATE TOP.....C-GRB-01-GPXX

FLAT SHIPPING AND EASY ASSEMBLY

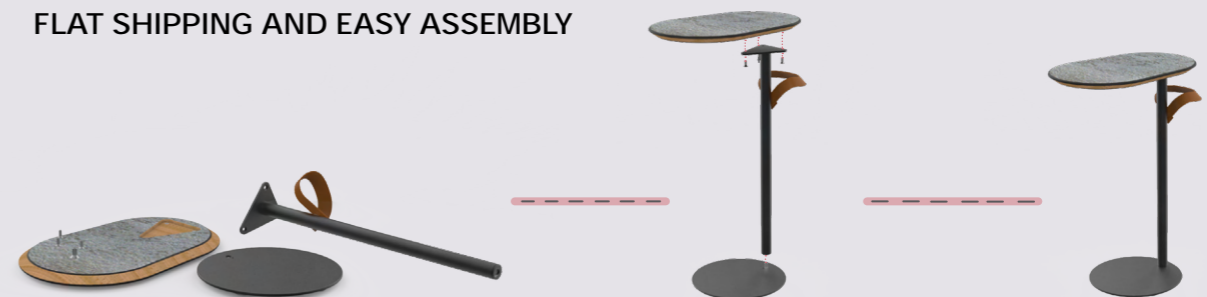



BUFFET SOLUTIONS

www.mogogo-buffet.com
info@mogogo-buffet.com

