

mogogo
BUFFET SOLUTIONS

Grabit
PORTABLE TABLES

TABLE

ASSEMBLY INSTRUCTIONS

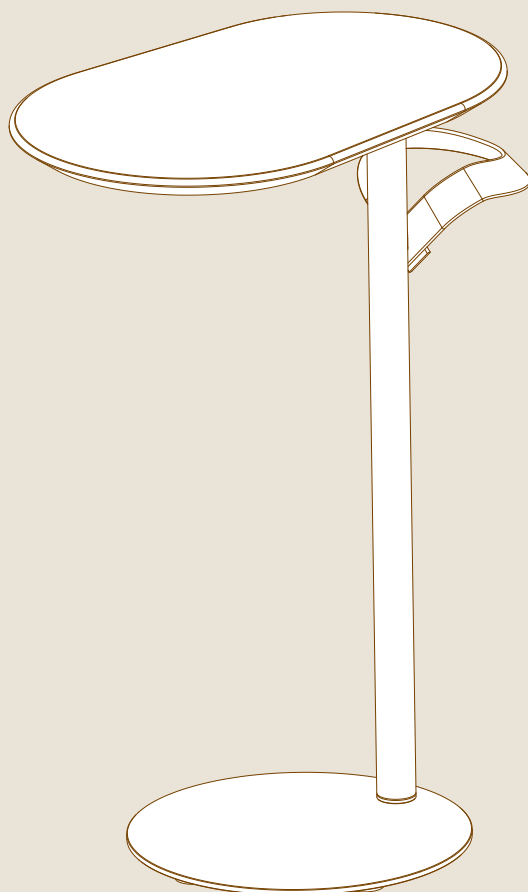

PARTS

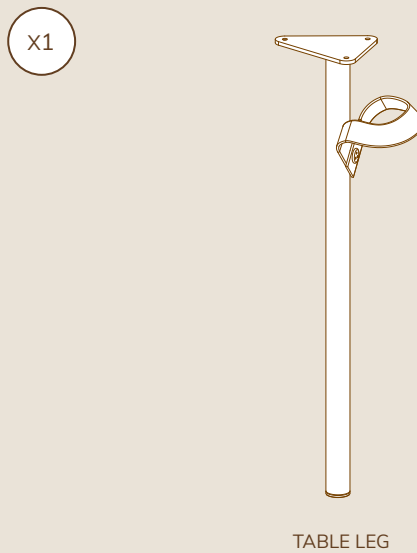
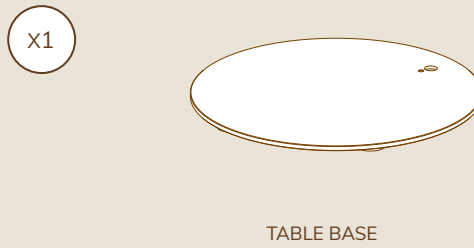
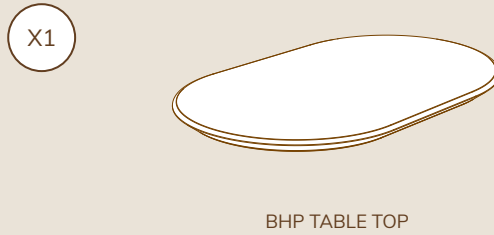
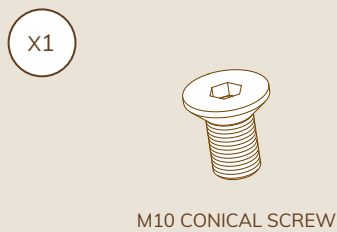
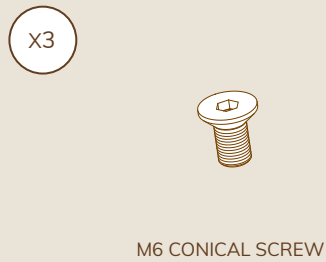

ASSEMBLY

- 1 Put the BHP table top up side down and place the table leg.

Tighten the M6 screws with its Allen key.

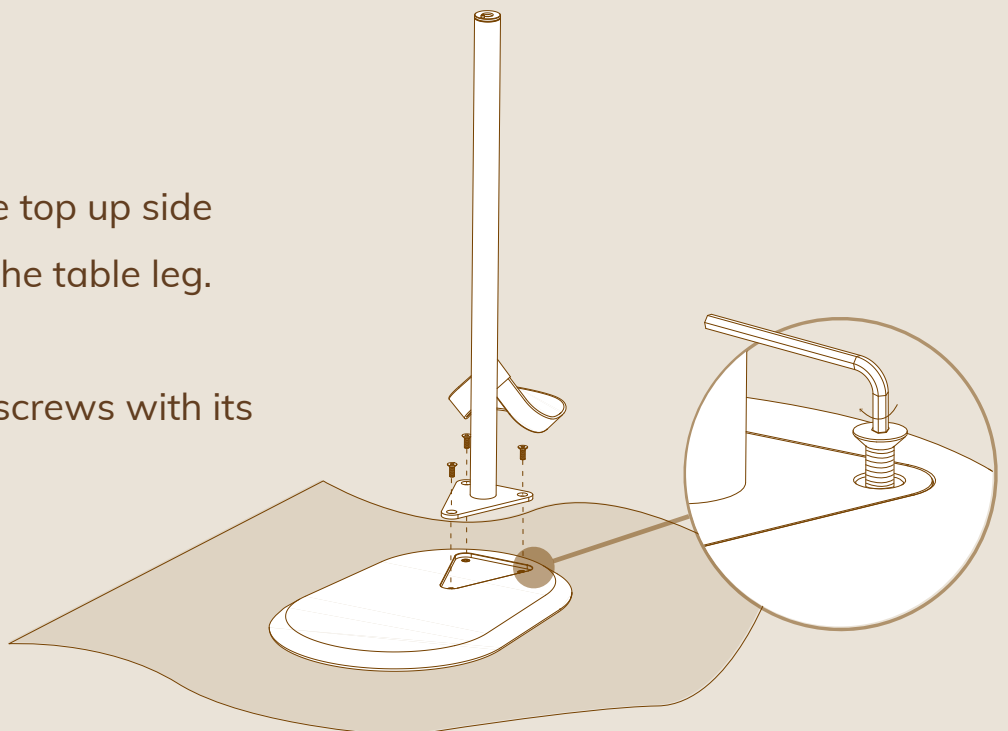

2

Place the table base on the other side of the leg.
Insert the pin into its dedicated hole.

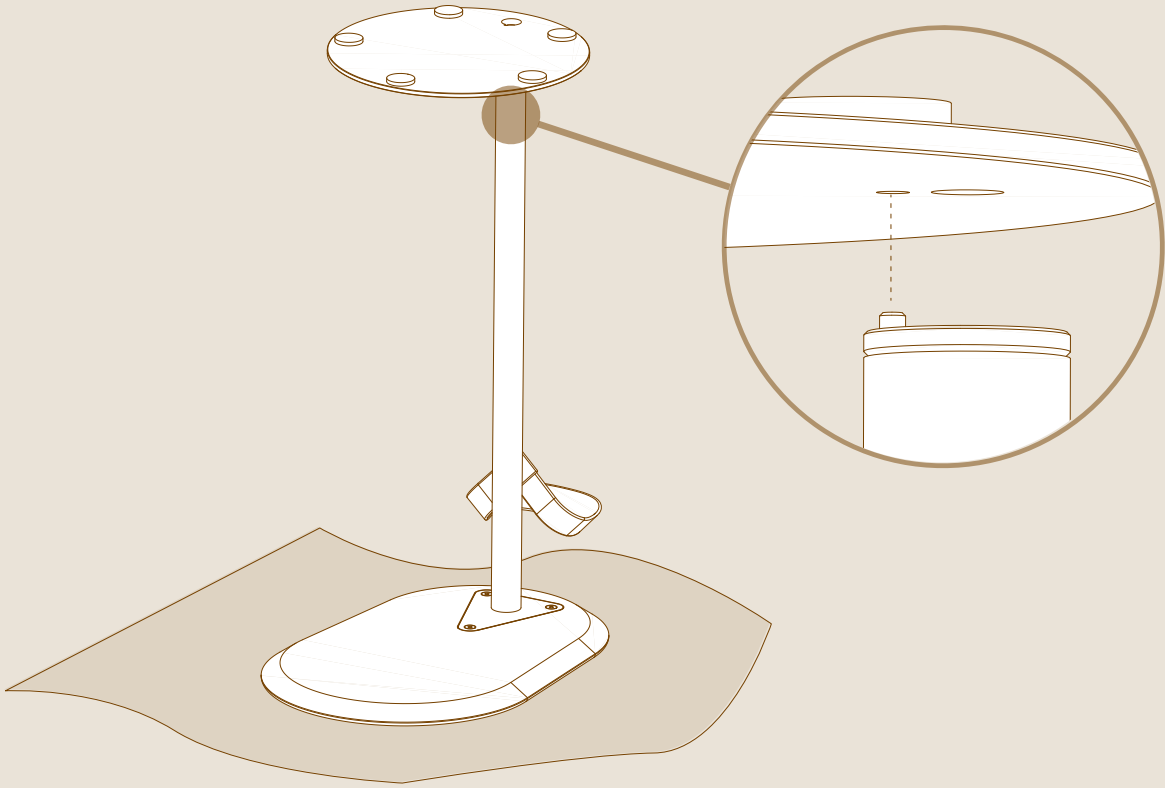

3

Tighten the M10 screw with its Allen key

