

Modular

SYSTEM

CLASSIC CORNER UNIT

ASSEMBLY INSTRUCTIONS

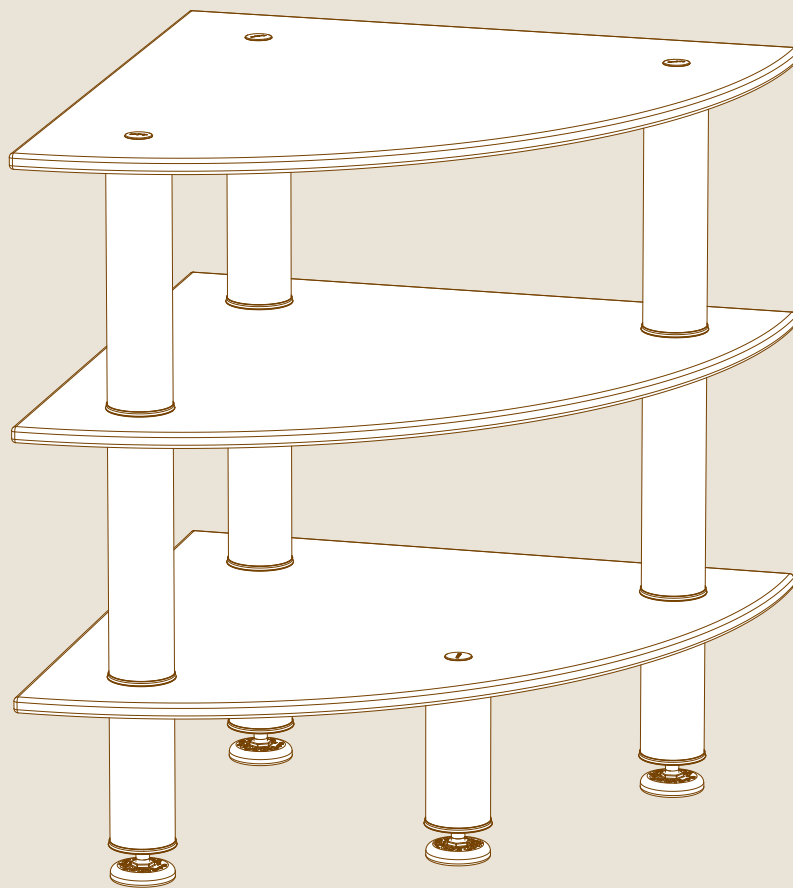

PARTS

X1



ALLEN KEY FOR M16

X4



M16 ALLEN SCREWS

X4



SCREW CAPS

X2

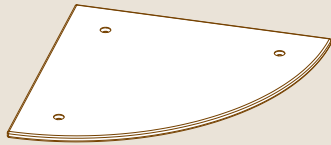

CORNER UNIT PANEL L29.5" W29.5" | L75cm W75cm

X1

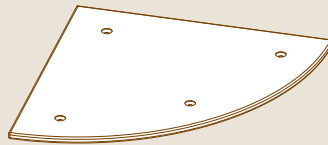

CORNER UNIT BOTTOM PANEL L29.5" W29.5" | L75cm W75cm

X6



12" | 30cm SEGMENTS

X4



ADJUSTABLE LEGS

ASSEMBLY

1

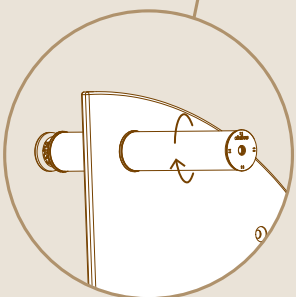
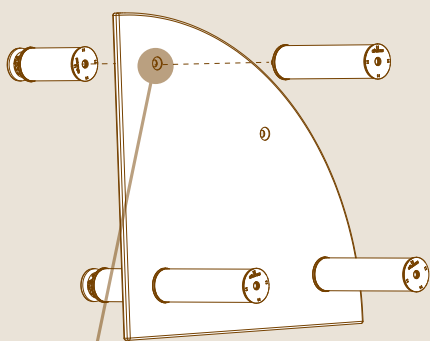

2

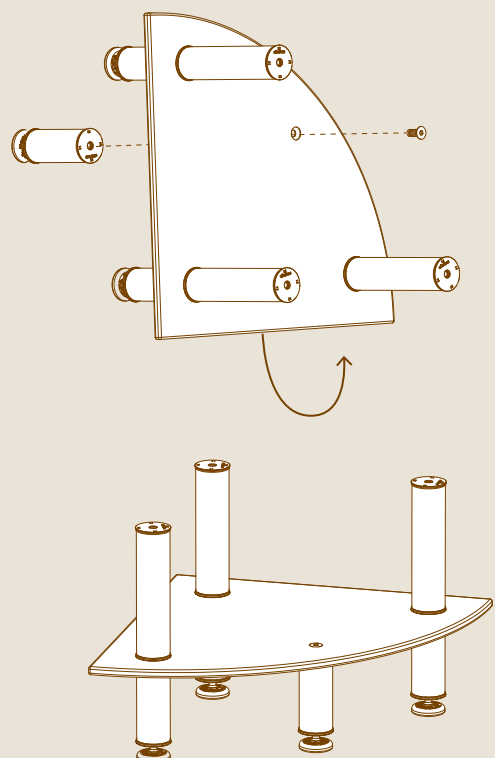

3

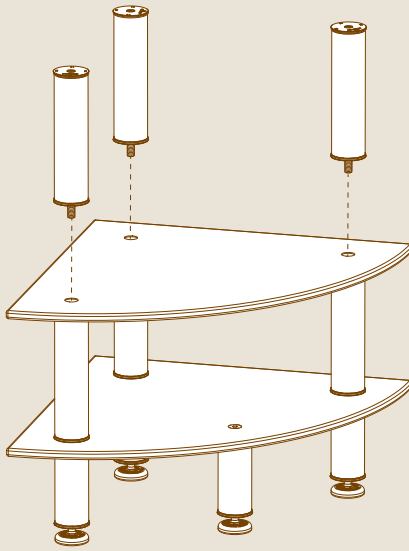

4

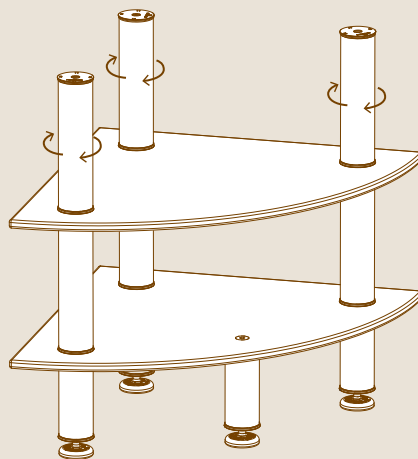

5

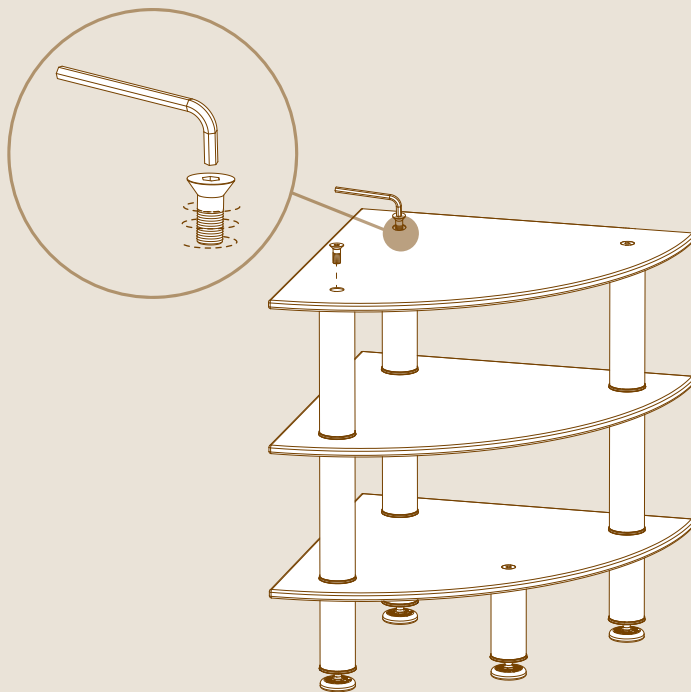

6

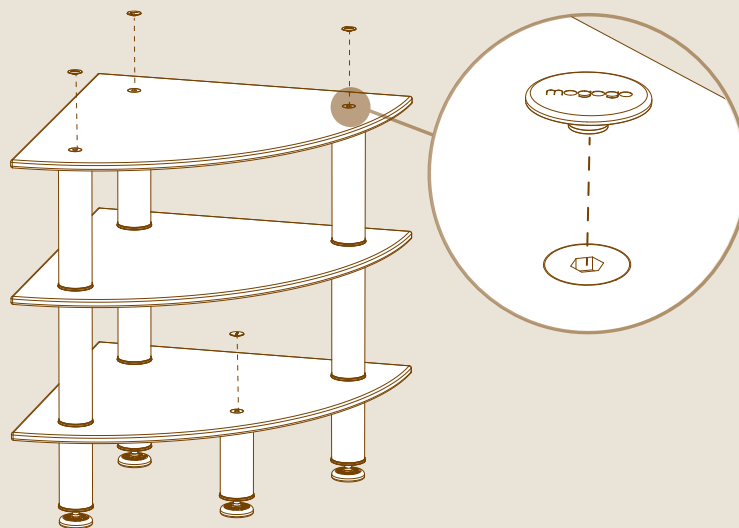

7

Use multiple Corner Units to create endless configuration shapes.

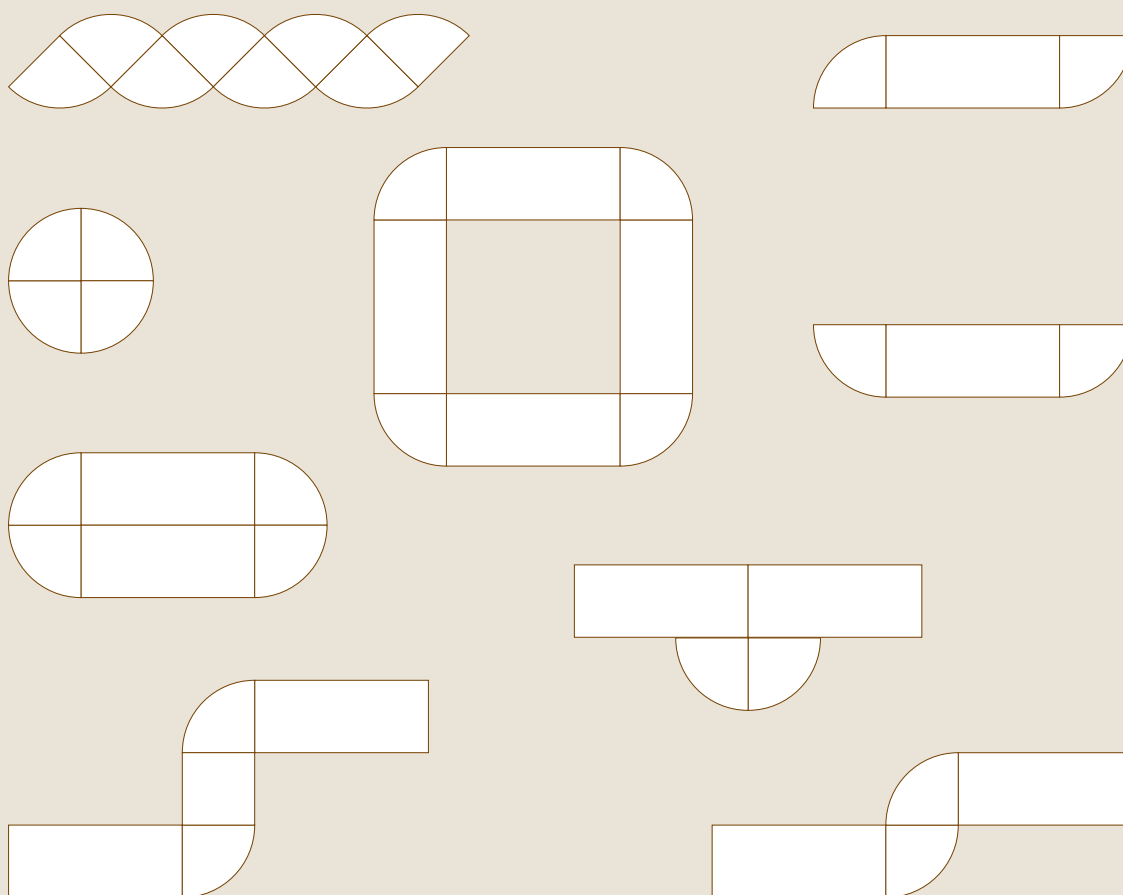

YOU'RE ALL DONE, WAY TO GO!