

Modular

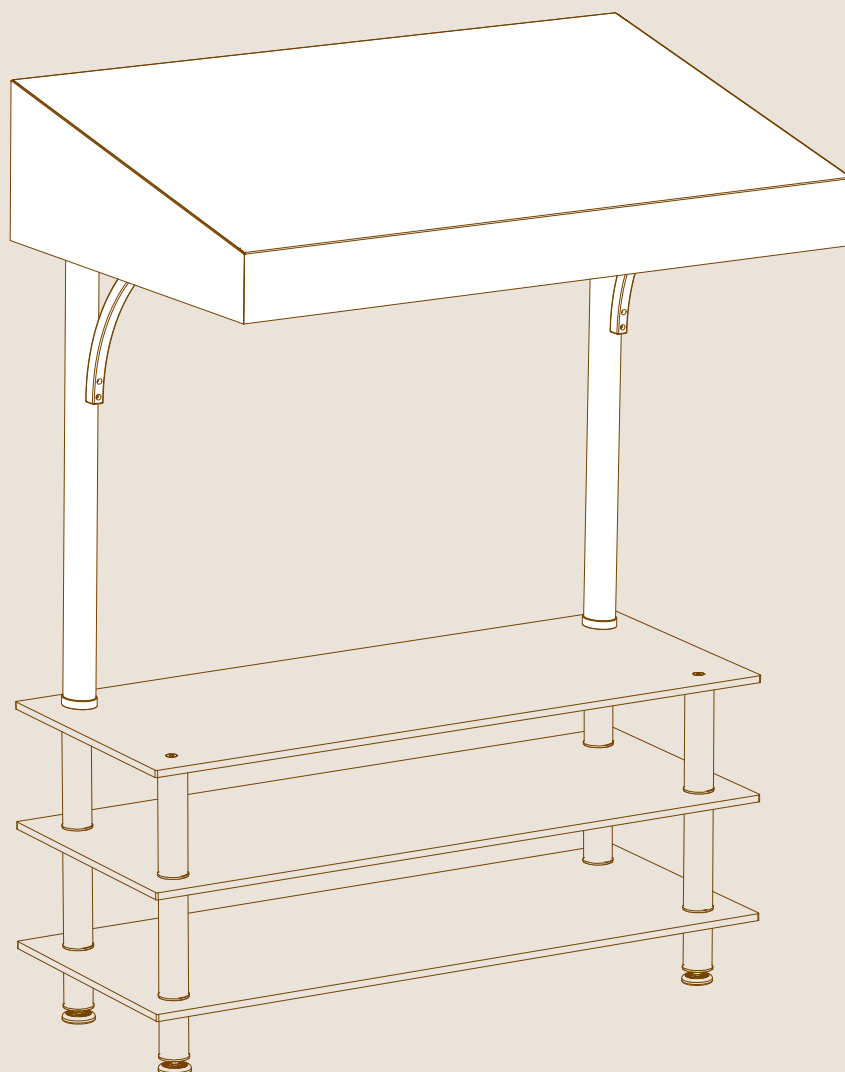





SYSTEM

CANOPY

ASSEMBLY INSTRUCTIONS

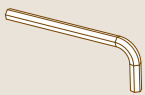
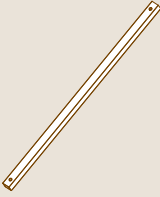

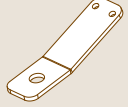
PARTS

 <p>X1</p> <p>ALLEN KEY FOR M6</p>	 <p>X2</p> <p>ALUMINIUM PROFILES L71" L180cm</p>	 <p>X2</p> <p>VERTICAL POLES L59" L149cm</p>	 <p>X2</p> <p>ADAPTORS</p>
 <p>X1</p> <p>ALLEN KEY FOR M16</p>	 <p>X2</p> <p>ALUMINIUM PROFILES L34" L85cm</p>	 <p>X2</p> <p>SUPPORT ARCHES</p>	 <p>X4</p> <p>FRAME CORNERS</p>
 <p>X10</p> <p>M6 ALLEN SCREWS</p>			 <p>X2</p> <p>CONNECTORS</p>
 <p>X2</p> <p>ROUND CAP M16 ALLEN SCREWS</p>			 <p>X1</p> <p>CORDURA COVER</p>

ASSEMBLY

- 1 Assemble the frame by clicking the 4 plastic frame corners.

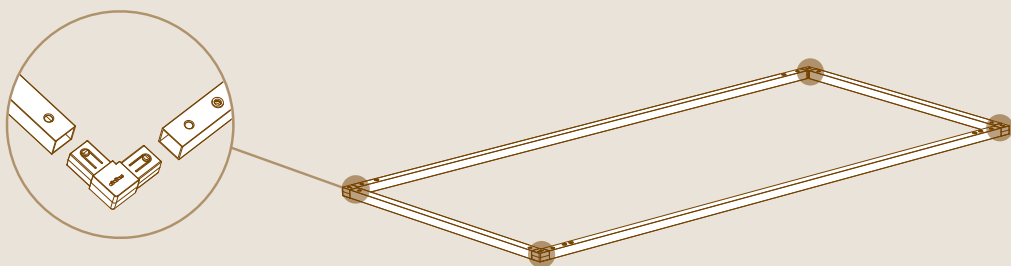

- 2 Attach the support arches to the frame on the side with the single hole.

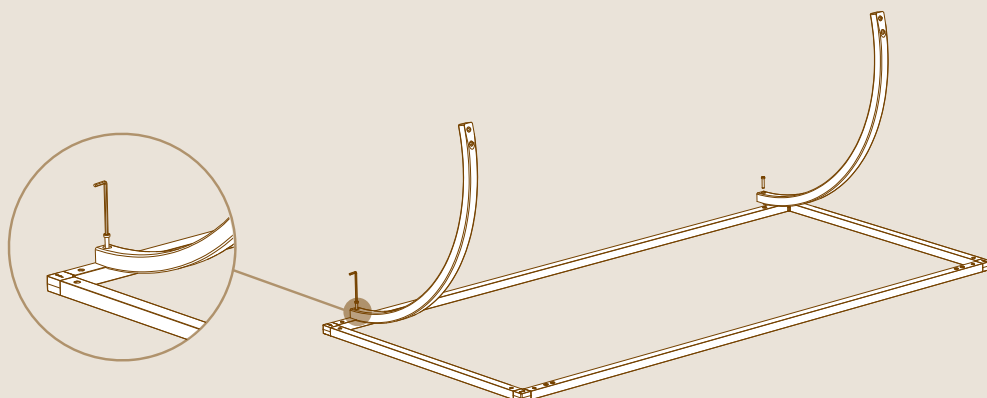

- 3** Screw on the angled connectors to the poles, as shown here facing the opposite side of the holes in the pipe.

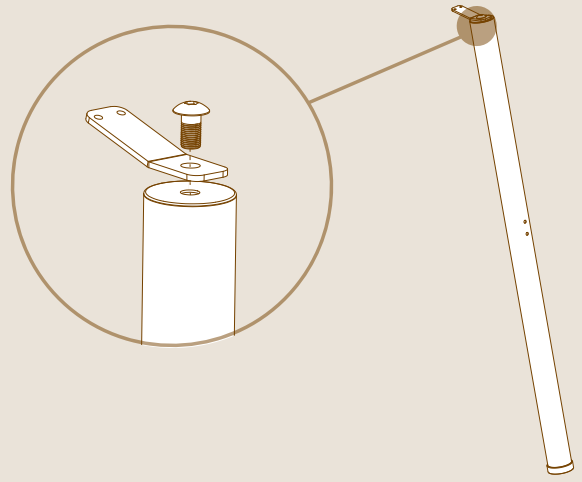

- 4** Attach the poles to the frame and to the bamboo support arches.

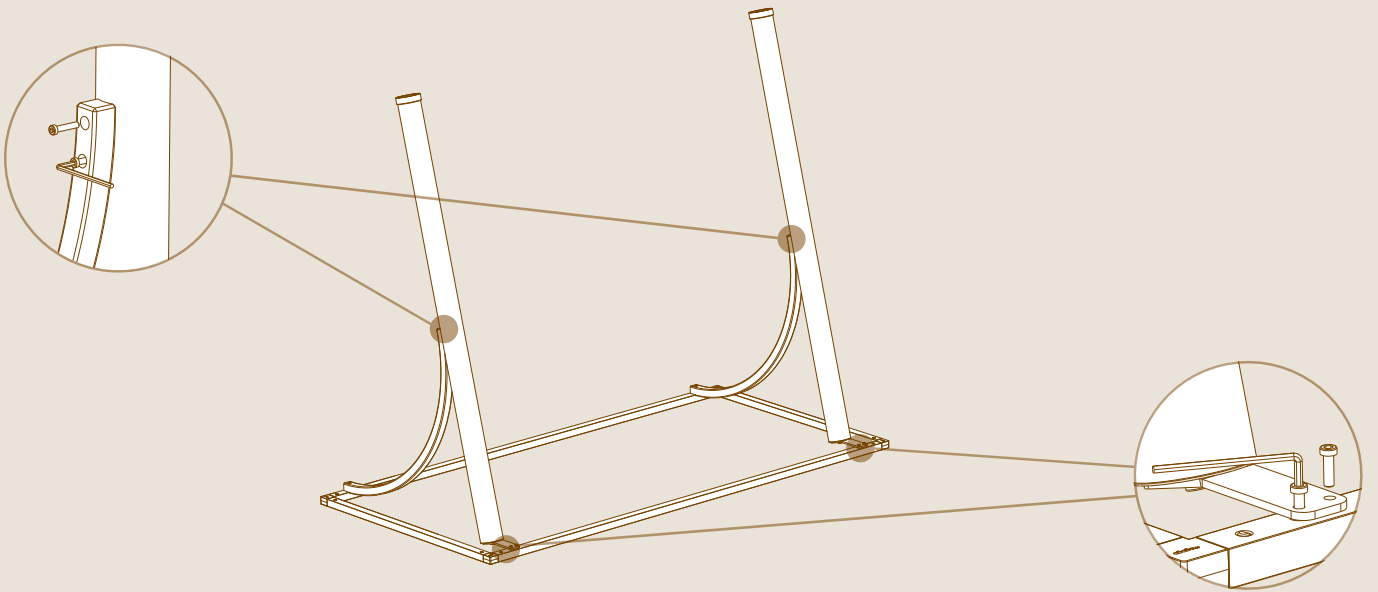

- 5** Attach the adaptors to your large unit table.

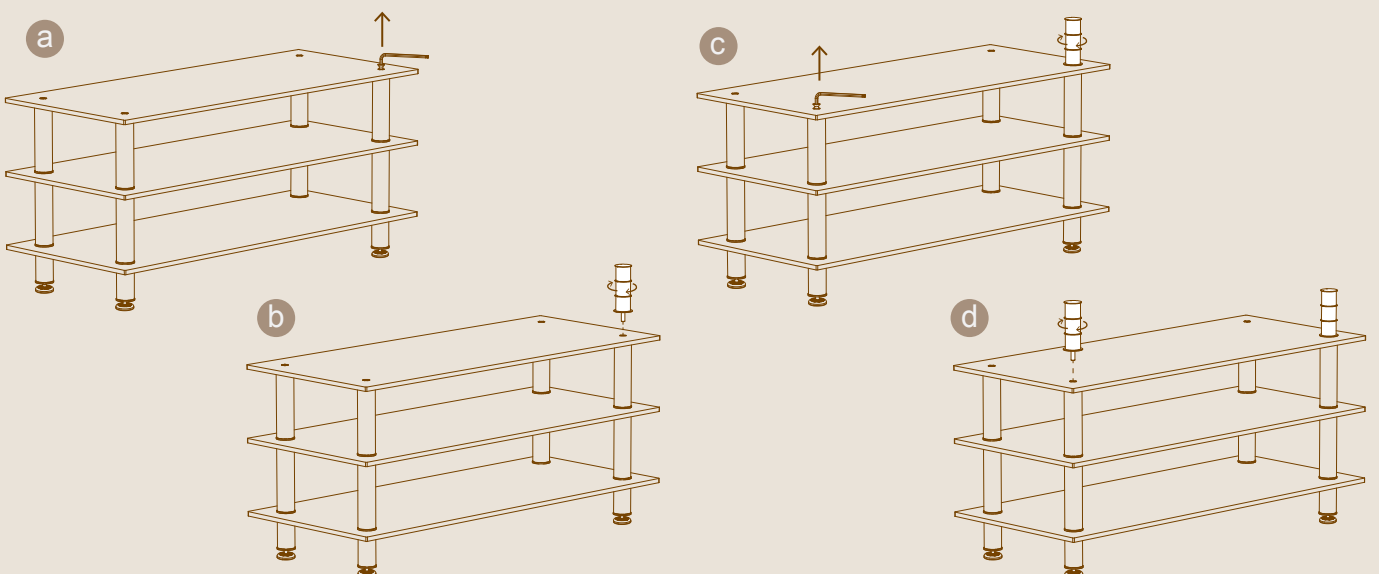

- 6** Flip the canopy base onto the connectors. With the help of an additional person, each person should hold one side.

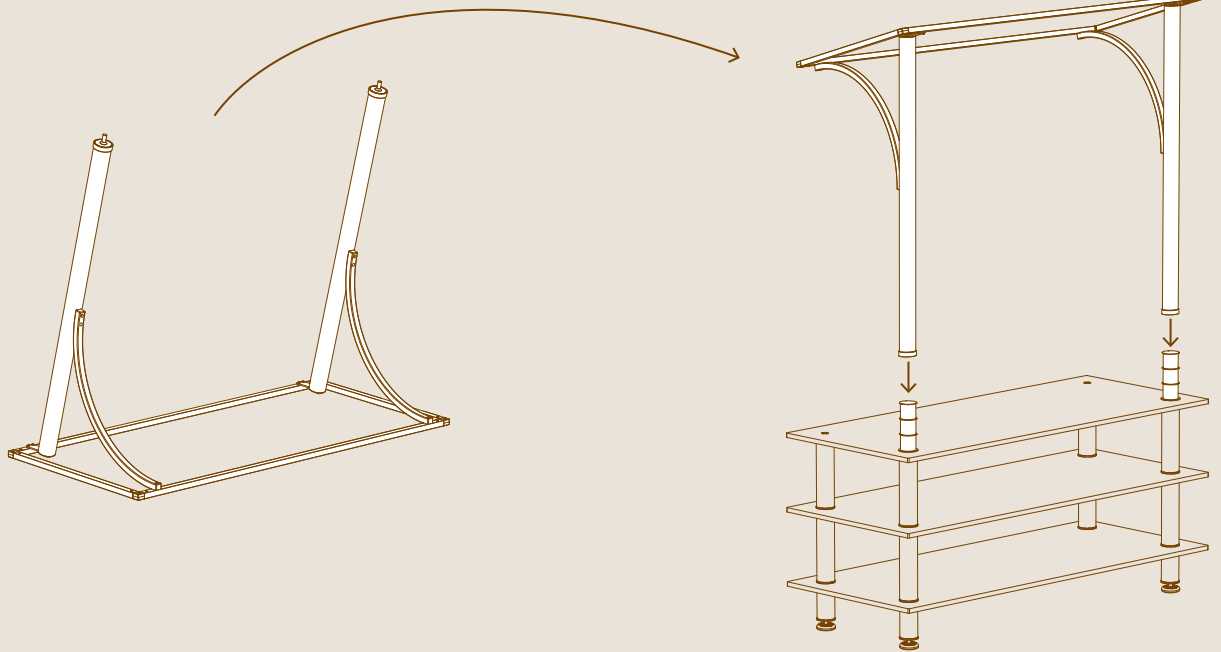

- 7** Spread the fabric over the frame, starting with the side with the long stitches, on the highest corners of the frame.

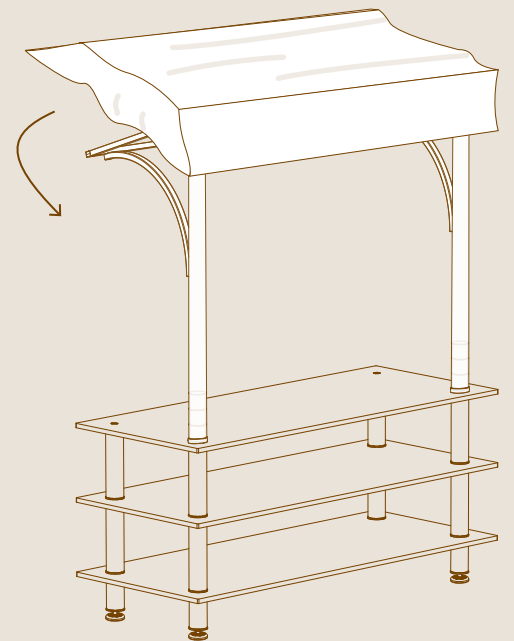

GREAT JOB, YOUR GOOD TO GO!