

POLO
TABLES

BAR TABLES

ASSEMBLY INSTRUCTIONS

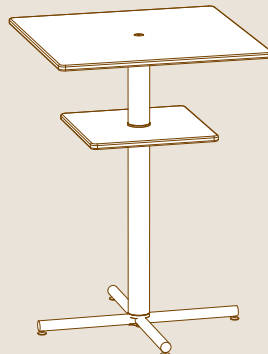
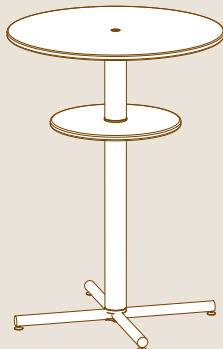
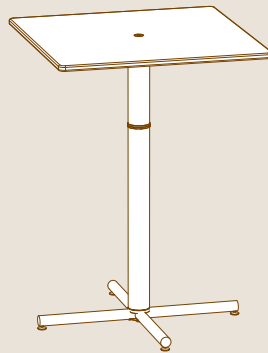
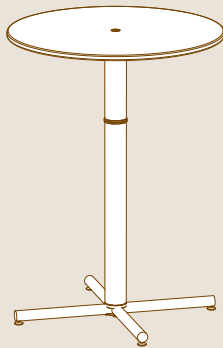

PARTS

X1



ALLEN KEY FOR M16

X1



M16 ALLEN SCREW

X1



SCREW CAP

X1



30" ROUND TOP $\varnothing 30"$ | $\varnothing 76\text{cm}$

OR



30" SQUARE TOP 30" | 76cm

OPTIONAL



18" ROUND TOP $\varnothing 18"$ | $\varnothing 46\text{cm}$

OR



18" SQUARE TOP 18" | 46cm

X1



15" | 38cm SEGMENT

X1

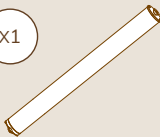

26" | 67cm SEGMENT

X1

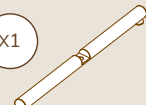

BOTTOM CROSS BASE

X1



TOP CROSS BASE

ASSEMBLY

1

Unscrew the top and bottom screws to disassemble 26" segment into parts.

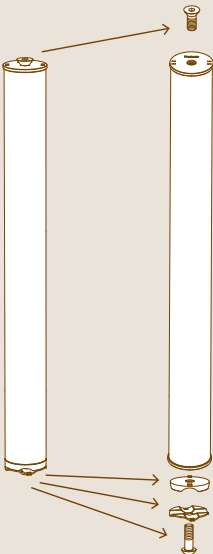

2

Make sure the pins are inserted into the main pole holes.

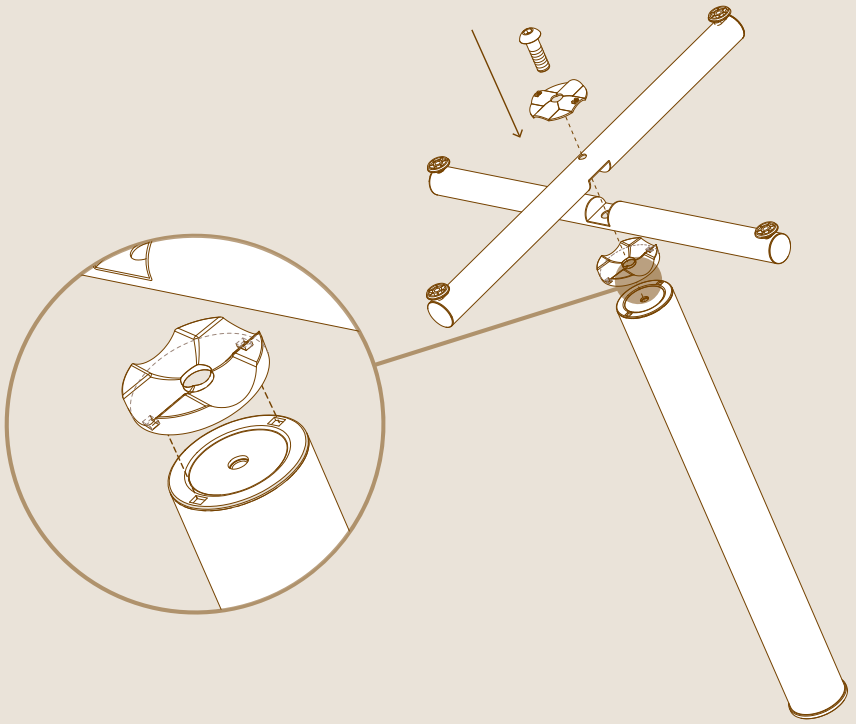

3

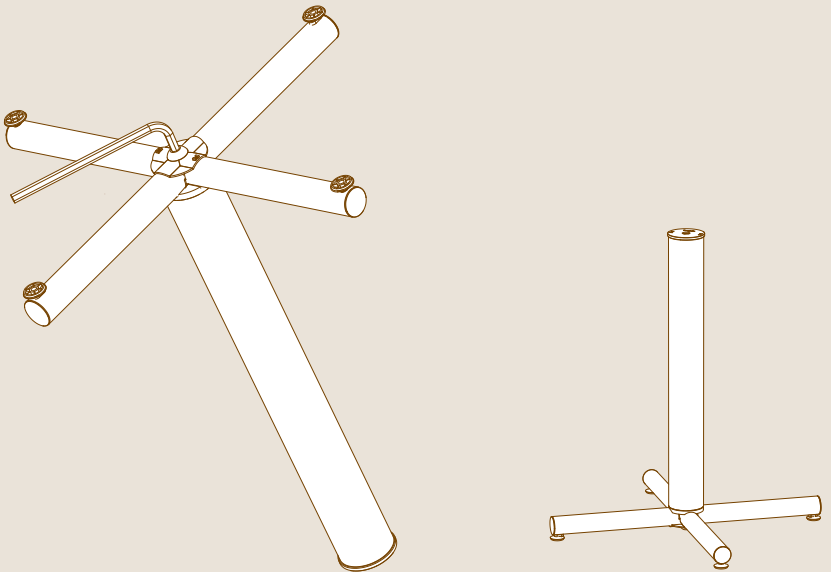

4

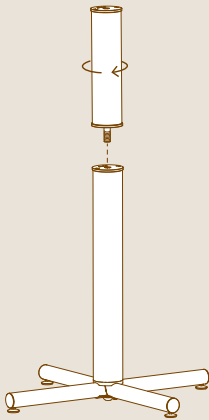

Optional shelf

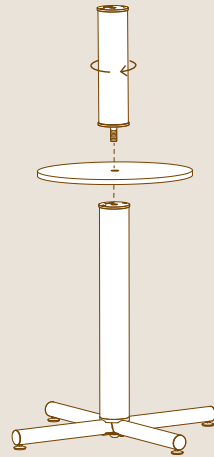
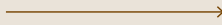

5

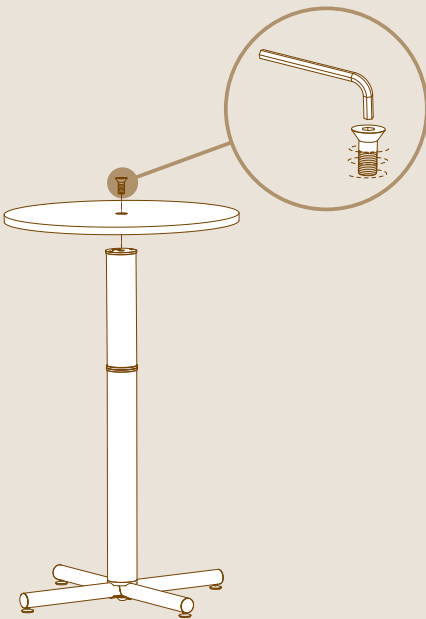

6

Tighten the tabletop by turning the plate clockwise by hand.

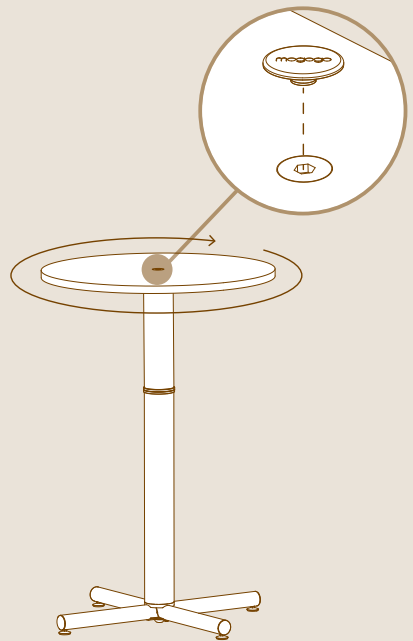

YOUR ALL DONE, WAY TO GO!